

■ Features

- $V_{DS} = -20V$
- $I_B = -3A$ ($V_{GS} = -4.5V$)
- $R_{DS(ON)} < 66m\Omega$ ($V_{GS} = -4.5V$)¹⁵
- $R_{BS(ON)} < 80m\Omega$ ($V_{GS} = -2.5V$)

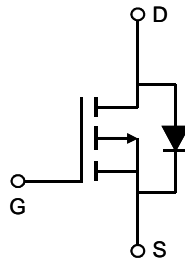
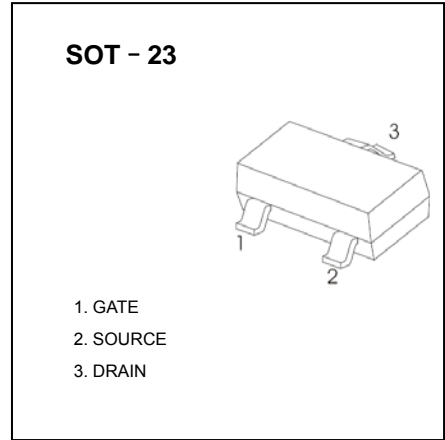

Absolute Maximum Ratings $T_A=25^\circ C$ unless otherwise noted

Parameter	Symbol	Maximum	Units
Drain-Source Voltage	V_{DS}	-20	V
Gate-Source Voltage	V_{GS}	± 8	V
Continuous Drain Current ^A	I_D	$T_A=25^\circ C$	A
		$T_A=70^\circ C$	
Pulsed Drain Current ^B	I_{DM}	-15	
Power Dissipation ^A	P_D	$T_A=25^\circ C$	W
		$T_A=70^\circ C$	
Junction and Storage Temperature Range	T_J, T_{STG}	-55 to 150	$^\circ C$

Thermal Characteristics

Parameter	Symbol	Typ	Max	Units
Maximum Junction-to-Ambient ^A	$R_{\theta JA}$	70	90	$^\circ C/W$
Maximum Junction-to-Ambient ^A		100	125	$^\circ C/W$
Maximum Junction-to-Lead ^C	$R_{\theta JL}$	63	80	$^\circ C/W$

Electrical Characteristics (T_J=25°C unless otherwise noted)

Symbol	Parameter	Conditions	Min	Typ	Max	Units
BV _{DSS}	Drain-Source Breakdown Voltage	I _D =-250μA, V _{GS} =0V	-20			V
I _{DSS}	Zero Gate Voltage Drain Current	V _{DS} =-20V, V _{GS} =0V T _J =55°C			-1 -5	μA
I _{GSS}	Gate-Body leakage current	V _{DS} =0V, V _{GS} =±8V			±100	nA
V _{GS(th)}	Gate Threshold Voltage	V _{DS} =V _{GS} , I _D =-250μA	-0.4	-0.65	-1	V
I _{D(ON)}	On state drain current	V _{GS} =-4.5V, V _{DS} =-5V	-15			A
R _{DS(ON)}	Static Drain-Source On-Resistance	V _{GS} =-4.5V, I _D =-3A V _{GS} =-2.5V, I _D =-2.6A			66 80	mΩ
g _{FS}	Forward Transconductance	V _{DS} =-5V, I _D =-3A		12		S
V _{SD}	Diode Forward Voltage	I _S =-1A, V _{GS} =0V		-0.7	-1	V
I _S	Maximum Body-Diode Continuous Current				-1.4	A
DYNAMIC PARAMETERS						
C _{iss}	Input Capacitance	V _{GS} =0V, V _{DS} =-10V, f=1MHz		560	745	pF
C _{oss}	Output Capacitance			80		pF
C _{rss}	Reverse Transfer Capacitance			70		pF
R _g	Gate resistance	V _{GS} =0V, V _{DS} =0V, f=1MHz		15	23	Ω
SWITCHING PARAMETERS						
Q _g	Total Gate Charge	V _{GS} =-4.5V, V _{DS} =-10V, I _D =-3A		8.5	11	nC
Q _{gs}	Gate Source Charge			1.2		nC
Q _{gd}	Gate Drain Charge			2.1		nC
t _{D(on)}	Turn-On DelayTime	V _{GS} =-4.5V, V _{DS} =-10V, R _L =3.3Ω, R _{GEN} =6Ω		7.2		ns
t _r	Turn-On Rise Time			36		ns
t _{D(off)}	Turn-Off DelayTime			53		ns
t _f	Turn-Off Fall Time			56		ns
t _{rr}	Body Diode Reverse Recovery Time	I _F =-3A, dI/dt=100A/μs		37	49	ns
Q _{rr}	Body Diode Reverse Recovery Charge	I _F =-3A, dI/dt=100A/μs		27		nC

A: The value of R_{θJA} is measured with the device mounted on 1 in² FR-4 board with 2oz. copper, in a still air environment with T_A=25° C. The value in any given application depends on the user's specific board design. The current rating is based on the t ≤ 10s thermal resistance rating.

B: Repetitive rating, pulse width limited by junction temperature.

C: The R_{θJA} is the sum of the thermal impedance from junction to lead R_{θJL} and lead to ambient.

D: The static characteristics in Figures 1 to 6 are obtained using 300μs pulse width, duty cycle 0.5% max.

E: These tests are performed with the device mounted on 1 in² FR-4 board with 2oz. Copper, in a still air environment with T_A=25° C. The SOA curve provides a single pulse rating.

TYPICAL ELECTRICAL AND THERMAL CHARACTERISTICS

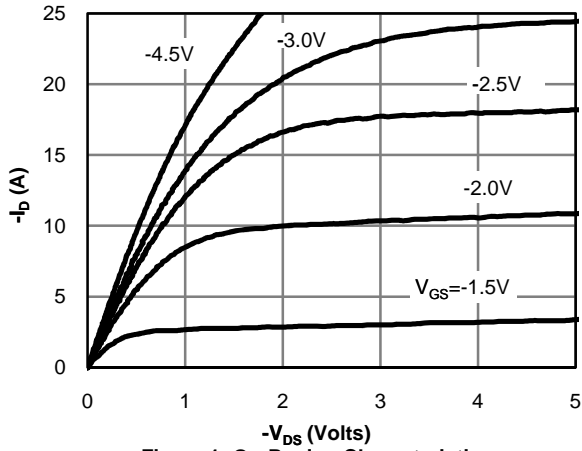

Figure 1: On-Region Characteristics

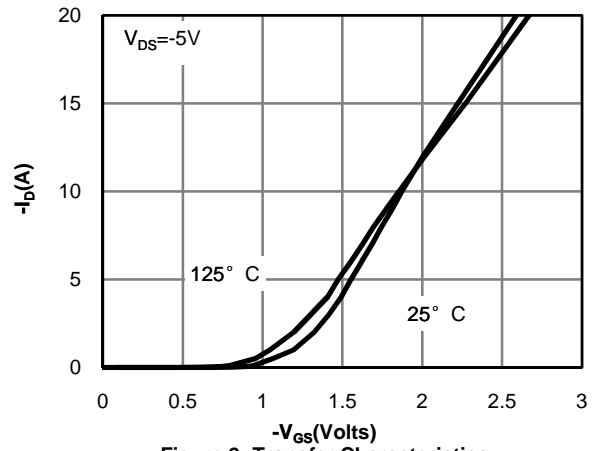

Figure 2: Transfer Characteristics

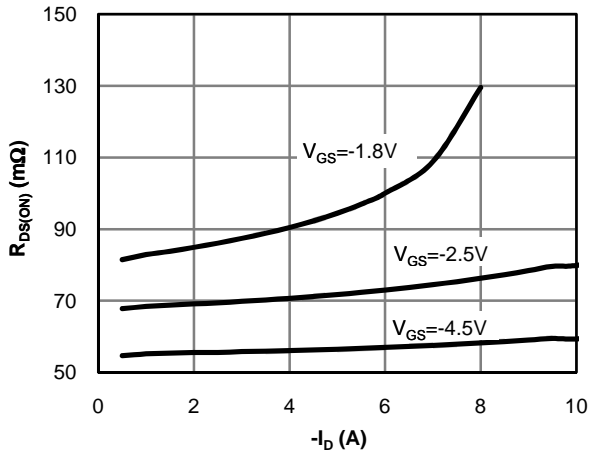

Figure 3: On-Resistance vs. Drain Current and Gate Voltage

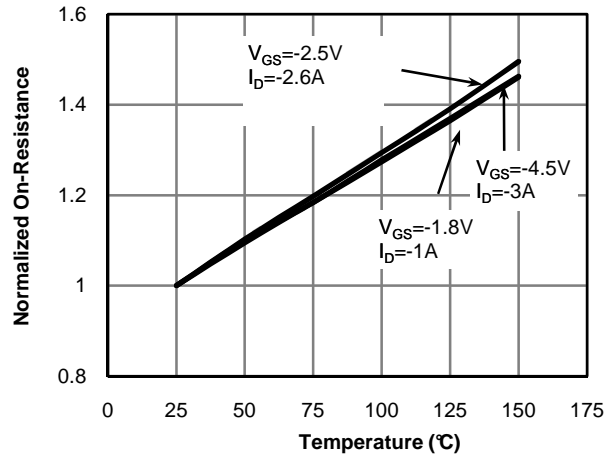

Figure 4: On-Resistance vs. Junction Temperature

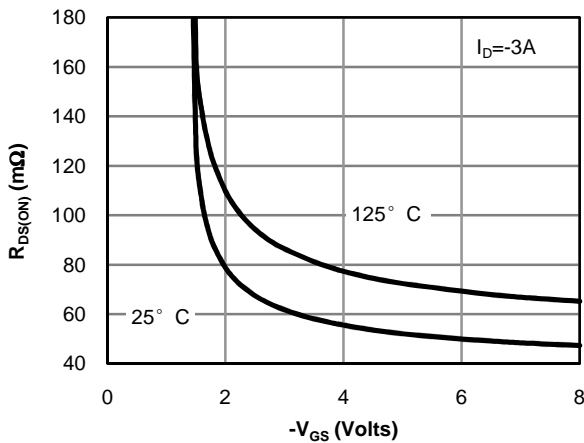

Figure 5: On-Resistance vs. Gate-Source Voltage

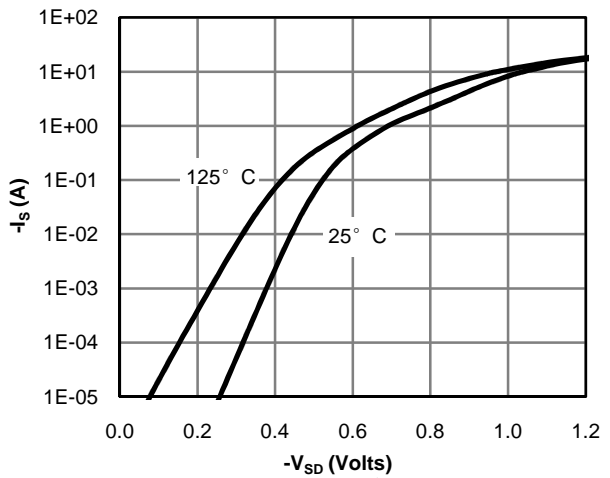

Figure 6: Body-Diode Characteristics

TYPICAL ELECTRICAL AND THERMAL CHARACTERISTICS

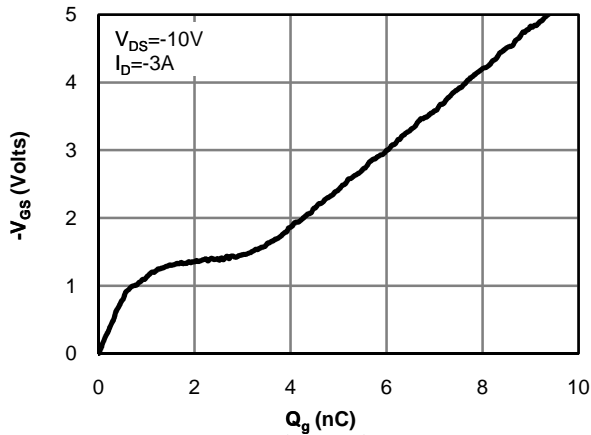

Figure 7: Gate-Charge Characteristics

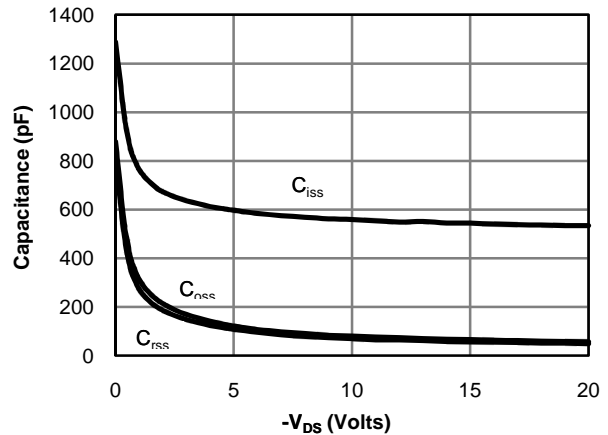

Figure 8: Capacitance Characteristics

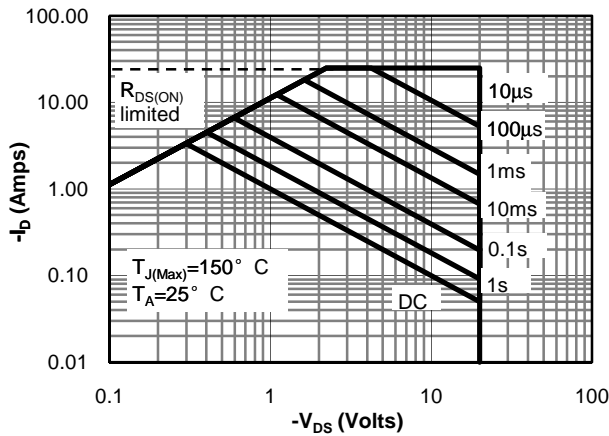

Figure 9: Maximum Forward Biased Safe Operating Area (Note E)

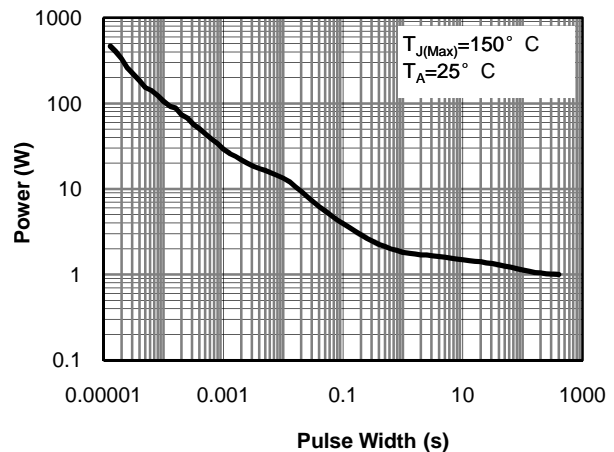

Figure 10: Single Pulse Power Rating Junction-to-Ambient (Note E)

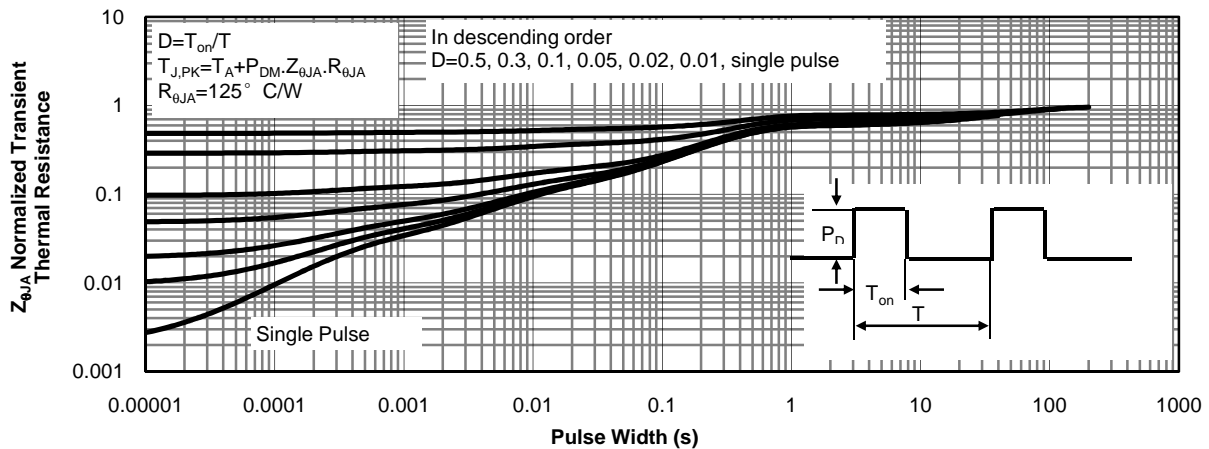
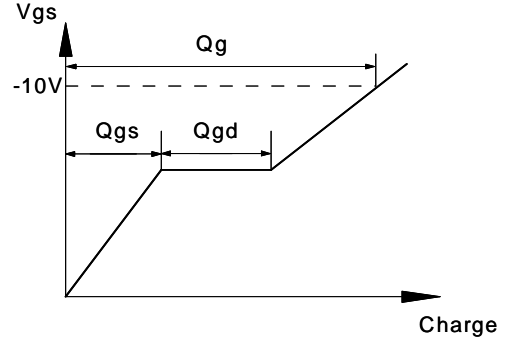
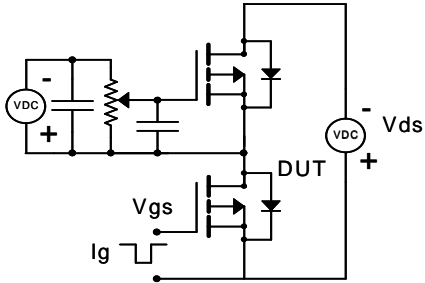
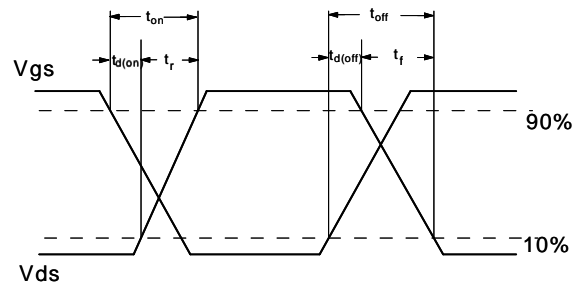
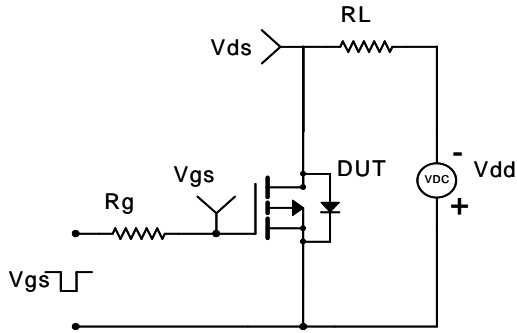

Figure 11: Normalized Maximum Transient Thermal Impedance (Note E)

Gate Charge Test Circuit & Waveform



Resistive Switching Test Circuit & Waveforms



Diode Recovery Test Circuit & Waveforms

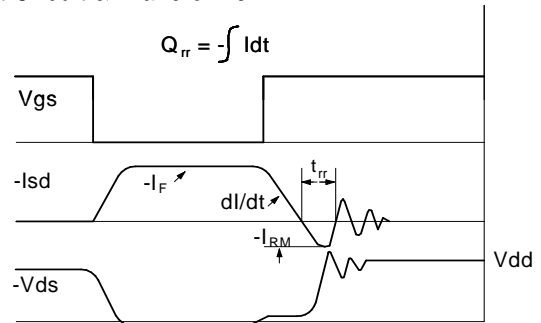
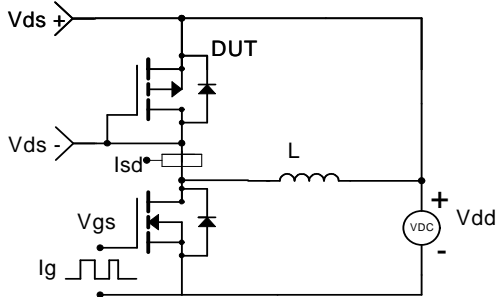

SOT-23 PACKAGE OUTLINE DIMENSIONS

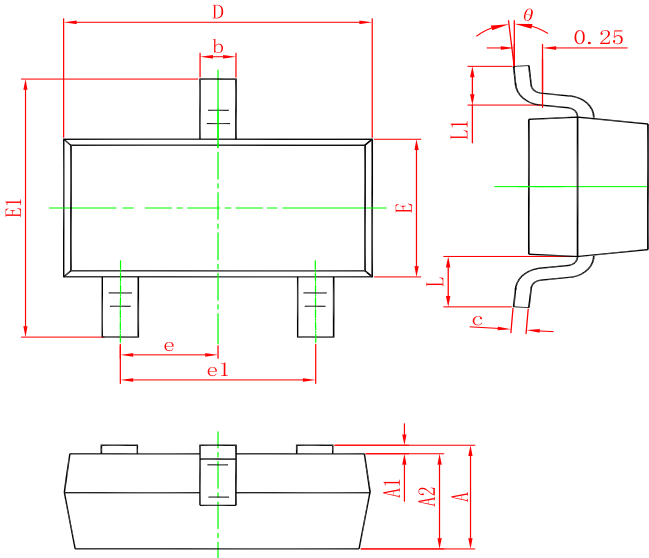

Symbol	Dimensions In Millimeters		Dimensions In Inches	
	Min.	Max.	Min.	Max.
A	0.900	1.150	0.035	0.045
A1	0.000	0.100	0.000	0.004
A2	0.900	1.050	0.035	0.041
b	0.300	0.500	0.012	0.020
c	0.080	0.150	0.003	0.006
D	2.800	3.000	0.110	0.118
E	1.200	1.400	0.047	0.055
E1	2.250	2.550	0.089	0.100
e	0.950 TYP.		0.037 TYP.	
e1	1.800	2.000	0.071	0.079
L	0.550 REF.		0.022 REF.	
L1	0.300	0.500	0.012	0.020
θ	0°	8°	0°	8°

Marking

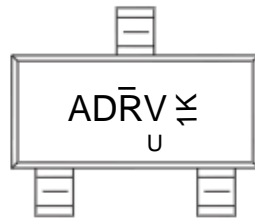

Ordering information

Order code	Package	Baseqty	Deliverymode
AO3413A	SOT-23	3000	Tape and reel