

■ Features

- $V_{DS} (V) = -30V$
- $I_D = -4.2 A (V_{GS} = -10V)$
- $R_{DS(ON)} < 50m\Omega (V_{GS} = -10V)$
- $R_{DS(ON)} < 65m\Omega (V_{GS} = -4.5V)$
- $R_{DS(ON)} < 120m\Omega (V_{GS} = -2.5V)$

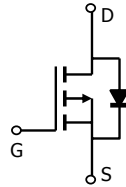
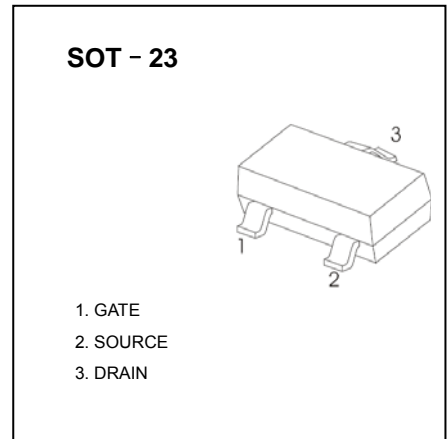

■ Absolute Maximum Ratings $T_a = 25^\circ C$

Parameter	Symbol	Rating	Unit
Drain-Source Voltage	V_{DS}	-30	V
Gate-Source Voltage	V_{GS}	± 12	
Continuous Drain Current $T_a = 25^\circ C$ $T_a = 70^\circ C$	I_D	-4.2	A
		-3.5	
Pulsed Drain Current	I_{DM}	-30	
Power Dissipation $T_a = 25^\circ C$ $T_a = 70^\circ C$	P_D	1.4	W
		1	
Thermal Resistance.Junction- to-Ambient $t \leq 10s$	R_{thJA}	90	$^\circ C/W$
Thermal Resistance.Junction- to-Ambient		125	
Thermal Resistance.Junction- to-Case	R_{thJC}	60	
Junction Temperature	T_J	150	$^\circ C$
Junction and Storage Temperature Range	T_{stg}	-55 to 150	

■ Electrical Characteristics Ta = 25°C

Parameter	Symbol	Test Conditions	Min	Typ	Max	Unit
Drain-Source Breakdown Voltage	V _{DSS}	I _D =-250 μA, V _{GS} =0V	-30			V
Zero Gate Voltage Drain Current	I _{DSS}	V _{DS} =-24V, V _{GS} =0V			-1	μA
		V _{DS} =-24V, V _{GS} =0V, T _J =55°C			-5	
Gate-Body leakage current	I _{GSS}	V _{DS} =0V, V _{GS} =±12V			±100	nA
Gate Threshold Voltage	V _{GS(th)}	V _{DS} =V _{GS} I _D =-250 μA	-0.4		-1.3	V
Static Drain-Source On-Resistance	R _{DS(on)}	V _{GS} =-10V, I _D =-4.2A			50	mΩ
		V _{GS} =-4.5V, I _D =-4A			65	
		V _{GS} =-2.5V, I _D =-1A			120	
On state drain current	I _{D(on)}	V _{GS} =-4.5V, V _{DS} =-5V	-25			A
Forward Transconductance	g _{FS}	V _{DS} =-5V, I _D =-5A	7	11		S
Input Capacitance	C _{iss}	V _{GS} =0V, V _{DS} =-15V, f=1MHz		954		pF
Output Capacitance	C _{oss}			115		
Reverse Transfer Capacitance	C _{rss}			77		
Gate resistance	R _g	V _{GS} =0V, V _{DS} =0V, f=1MHz		6		Ω
Total Gate Charge	Q _g	V _{GS} =-4.5V, V _{DS} =-15V, I _D =-4A		9.4		nC
Gate Source Charge	Q _{gs}			2		
Gate Drain Charge	Q _{gd}			3		
Turn-On DelayTime	t _{d(on)}	V _{GS} =-10V, V _{DS} =-15V, R _L =3.6 Ω, R _{GEN} =6 Ω		6.3		ns
Turn-On Rise Time	t _r			3.2		
Turn-Off DelayTime	t _{d(off)}			38.3		
Turn-Off Fall Time	t _f			12		
Body Diode Reverse Recovery Time	t _{rr}	I _F =-4A, di/dt=100A/μs		20.2		
Body Diode Reverse Recovery Charge	Q _{rr}	I _F =5A, di/dt=100A/μs		11.2		nC
Maximum Body-Diode Continuous Current	I _S				-2.2	A
Diode Forward Voltage	V _{SD}	I _S =-1A, V _{GS} =0V		-0.75	-1	V

■ Typical Characteristics

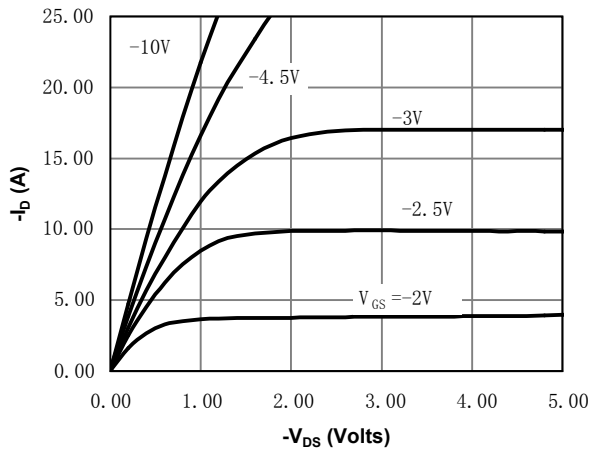

Fig 1: On-Region Characteristics

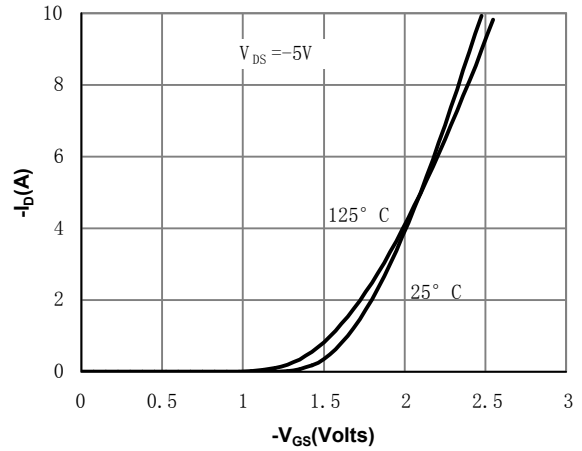

Figure 2: Transfer Characteristics

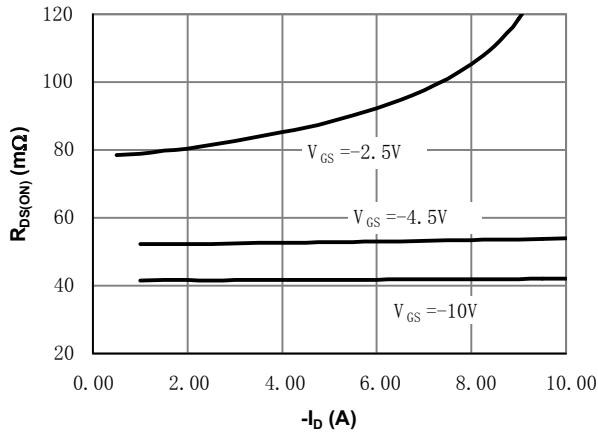

Figure 3: On-Resistance vs. Drain Current and Gate Voltage

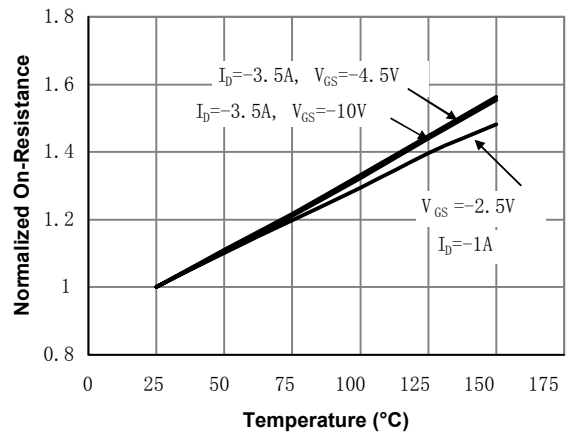

Figure 4: On-Resistance vs. Junction Temperature

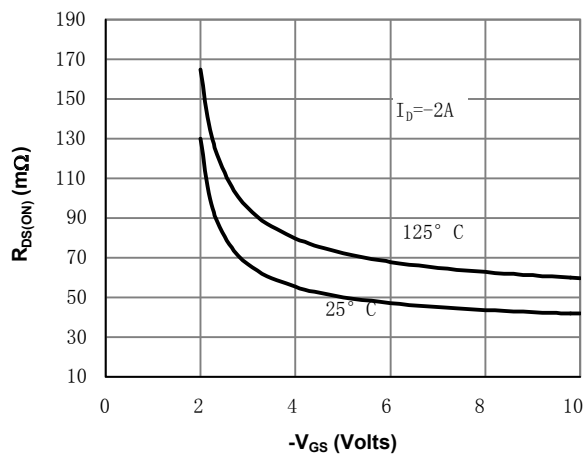

Figure 5: On-Resistance vs. Gate-Source Voltage

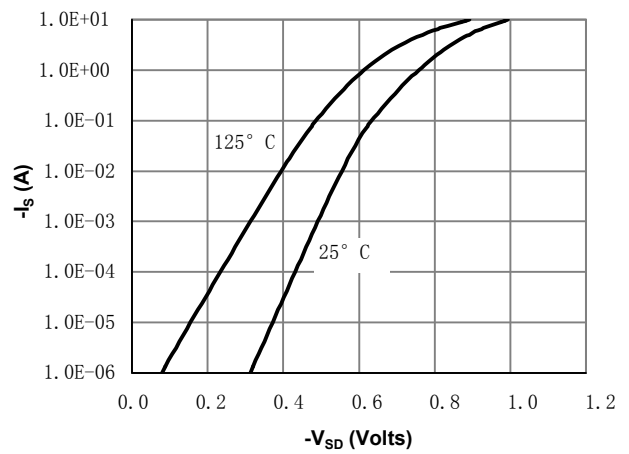

Figure 6: Body-Diode Characteristics

■ Typical Characteristics

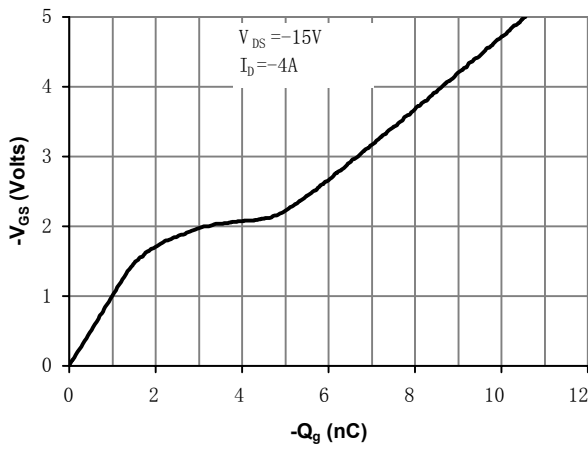

Figure 7: Gate-Charge Characteristics

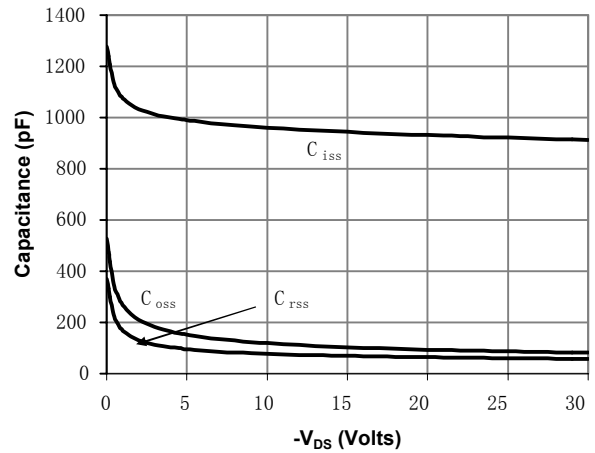

Figure 8: Capacitance Characteristics

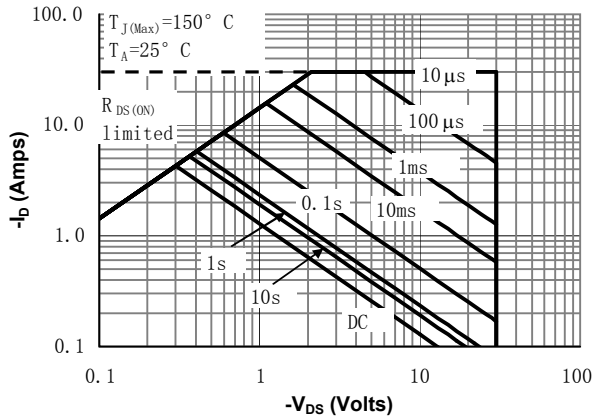

Figure 9: Maximum Forward Biased Safe Operating Area (Note E)

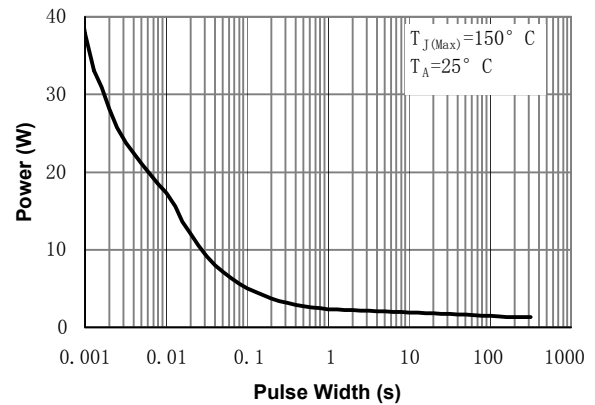

Figure 10: Single Pulse Power Rating Junction-to-Ambient (Note E)

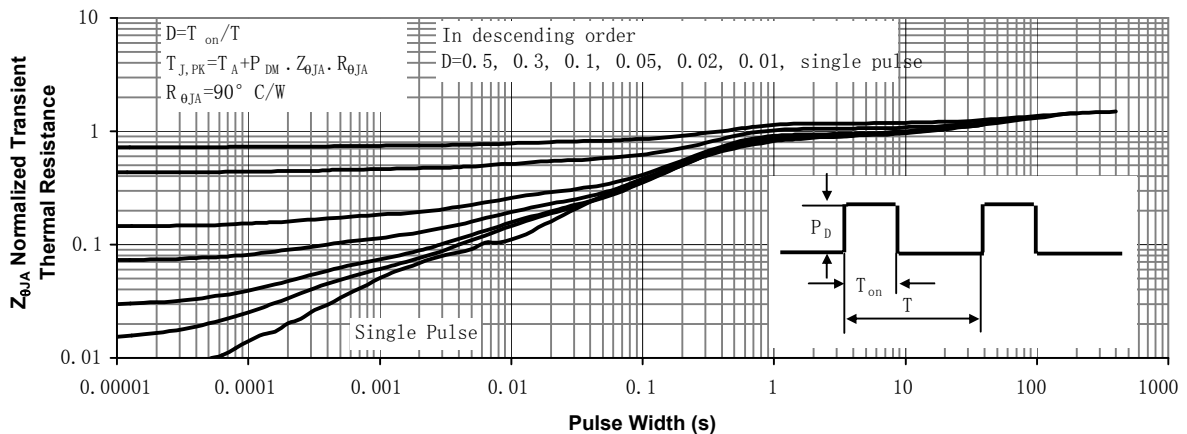
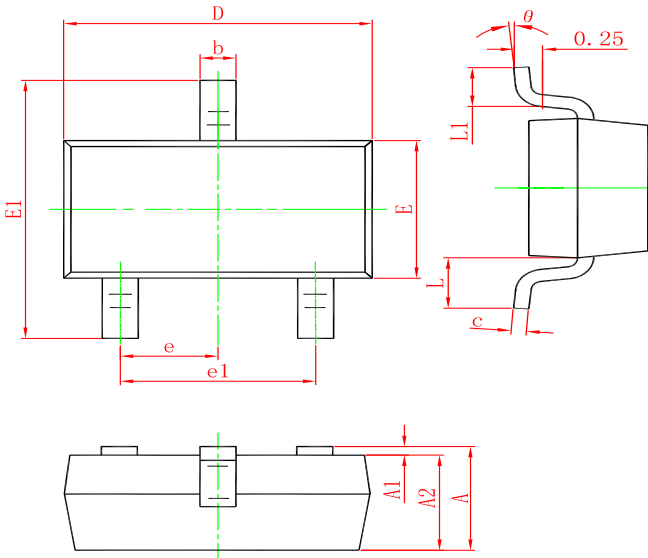

Figure 11: Normalized Maximum Transient Thermal Impedance

SOT-23 PACKAGE OUTLINE DIMENSIONS



Symbol	Dimensions In Millimeters		Dimensions In Inches	
	Min.	Max.	Min.	Max.
A	0.900	1.150	0.035	0.045
A1	0.000	0.100	0.000	0.004
A2	0.900	1.050	0.035	0.041
b	0.300	0.500	0.012	0.020
c	0.080	0.150	0.003	0.006
D	2.800	3.000	0.110	0.118
E	1.200	1.400	0.047	0.055
E1	2.250	2.550	0.089	0.100
e	0.950 TYP.		0.037 TYP.	
e1	1.800	2.000	0.071	0.079
L	0.550 REF.		0.022 REF.	
L1	0.300	0.500	0.012	0.020
θ	0°	8°	0°	8°

Marking

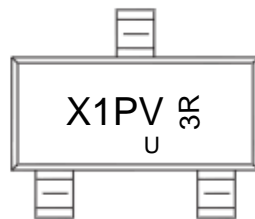

Ordering information

Order code	Package	Baseqty	Deliverymode
AO3401A	SOT-23	3000	Tape and reel