

## Description

The EL357 series combine an AlGaAs infrared emitting diode as the emitter which is optically coupled to a silicon planar phototransistor detector in a plastic SOP4 package.

With the robust coplanar double mold structure, UMW EL357 series provide the most stable isolation feature.

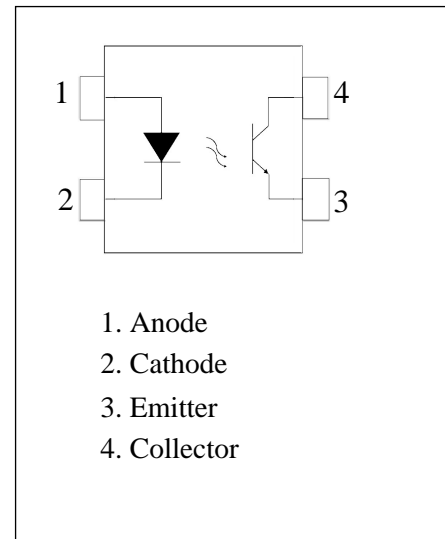
## Features

- High isolation 3750 VRMS
- CTR flexibility available see order information
- DC input with transistor output
- Operating temperature range - 55 °C to 110 °C
- REACH compliance
- Halogen free
- MSL class 1
- UL Recognized: UL1577, File No. E492440

## Applications

- Switch mode power supplies
- Programmable controllers
- Household appliances
- Office equipment

Structural schematic diagram



**ABSOLUTE MAXIMUM RATINGS**

PARAMETER	SYMBOL	VALUE	UNIT	NOTE
<b>INPUT</b>				
Forward Current	$I_F$	60	mA	
Peak Forward Current	$I_{FP}$	1	A	1
Reverse Voltage	$V_R$	6	V	
Input Power Dissipation	$P_I$	100	mW	
<b>OUTPUT</b>				
Collector - Emitter Voltage	$V_{CEO}$	35	V	
Emitter - Collector Voltage	$V_{ECO}$	7	V	
Collector Current	$I_C$	50	mA	
Output Power Dissipation	$P_O$	150	mW	
<b>COMMON</b>				
Total Power Dissipation	$P_{tot}$	200	mW	
Isolation Voltage	$V_{iso}$	3750	V <sub>rms</sub>	2
Operating Temperature	$T_{opr}$	-55~110	°C	
Storage Temperature	$T_{stg}$	-55~125	°C	
Soldering Temperature	$T_{sol}$	260	°C	

Note 1. 100 $\mu$ s pulse, 100Hz frequency

Note 2. AC For 1 Minute, R.H. = 40 ~ 60%

**ELECTRICAL OPTICAL CHARACTERISTICS at Ta=25°C**

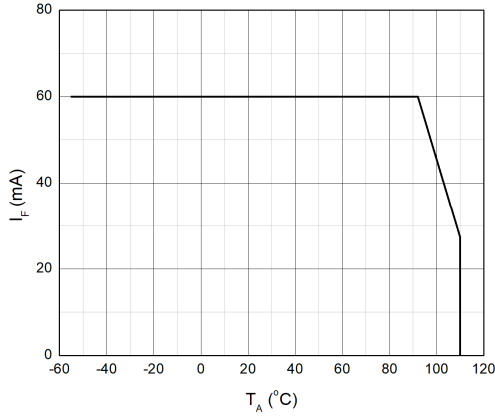
PARAMETER	SYMBOL	MIN	TYP.	MAX.	UNIT	TEST CONDITION	NOTE
INPUT							
Forward Voltage	V <sub>F</sub>	-	1.24	1.4	V	IF=10mA	
Reverse Current	I <sub>R</sub>	-	-	10	μA	VR=6V	
Input Capacitance	C <sub>in</sub>	-	10	-	pF	V=0, f=1kHz	
OUTPUT							
Collector Dark Current	I <sub>CEO</sub>	-	-	100	nA	VCE=20V, IF=0	
Collector-Emitter Breakdown Voltage	BV <sub>CEO</sub>	35	-	-	V	IC=0.1mA, IF=0	
Emitter-Collector Breakdown Voltage	BV <sub>ECO</sub>	7	-	-	V	IE=0.1mA, IF=0	
TRANSFER CHARACTERISTICS							
Current Transfer Ratio	EL357	CTR	50	-	600	%	IF=5mA, VCE=5V
	EL357A		80	-	160		
	EL357B		130	-	260		
	EL357C		200	-	400		
Collector-Emitter Saturation Voltage	V <sub>CE(sat)</sub>	-	0.06	0.2	V	IF=20mA, IC=1mA	
Isolation Resistance	R <sub>ISO</sub>	10 <sup>12</sup>	10 <sup>14</sup>	-	Ω	DC500V, 40 ~ 60% R.H.	
Floating Capacitance	C <sub>IO</sub>	-	0.4	1	pF	V=0, f=1MHz	
Cut-off Frequency	f <sub>c</sub>	-	80	-	kHz	VCE=2V, IC=2mA RL=100Ω, -3dB	4
Response Time (Rise)	t <sub>r</sub>	-	3	18	μs	VCE=2V, IC=2mA	3
Response Time (Fall)	t <sub>f</sub>	-	4	18	μs	RL=100Ω	3

Note 3. Fig.12&amp;13

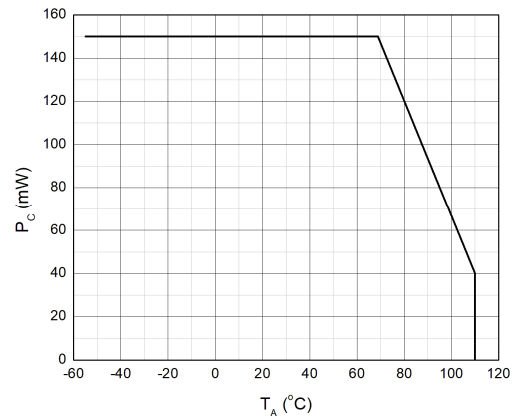
Note 4. Fig.14

**CHARACTERISTIC CURVES**

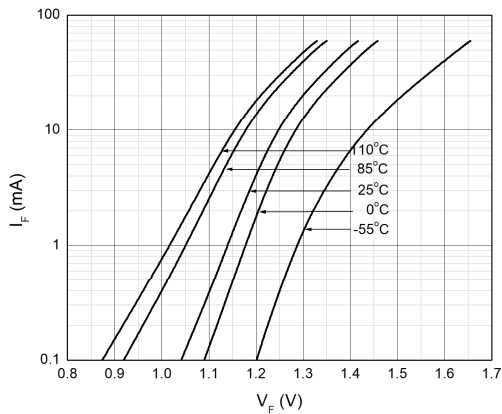
**Fig.1 Forward Current vs. Ambient Temperature**



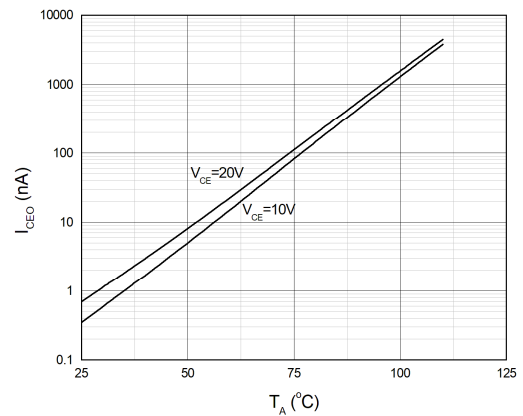
**Fig.2 Collector Power Dissipation vs. Ambient Temperature**



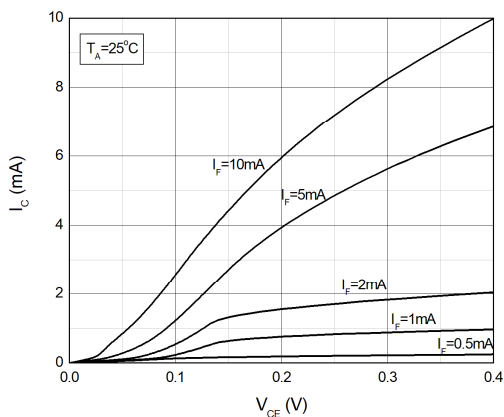
**Fig.3 Forward Current vs. Forward Voltage**



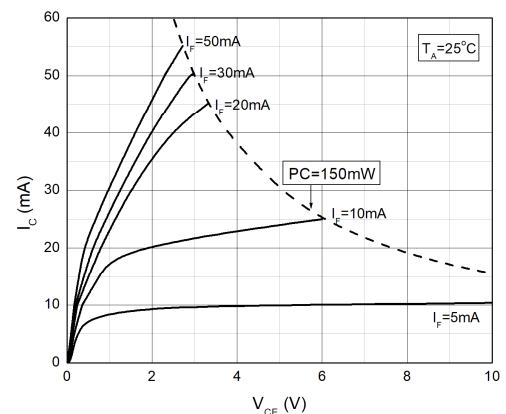
**Fig.4 Collector Dark Current vs. Ambient Temperature**



**Fig.5 Collector Current vs. Collector-emitter Voltage**

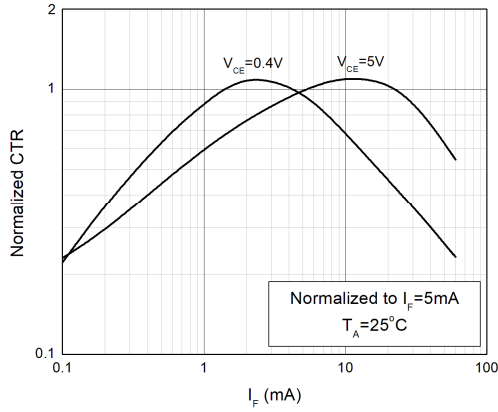


**Fig.6 Collector Current vs. Collector-emitter Voltage**

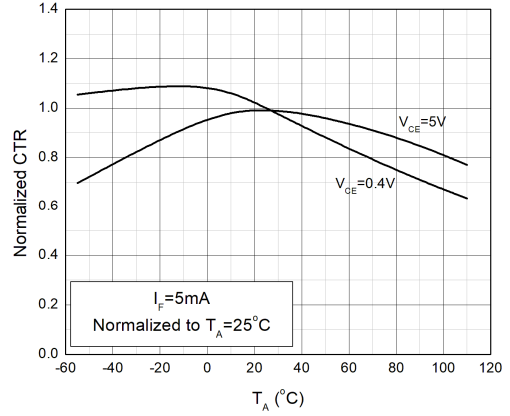


**CHARACTERISTIC CURVES**

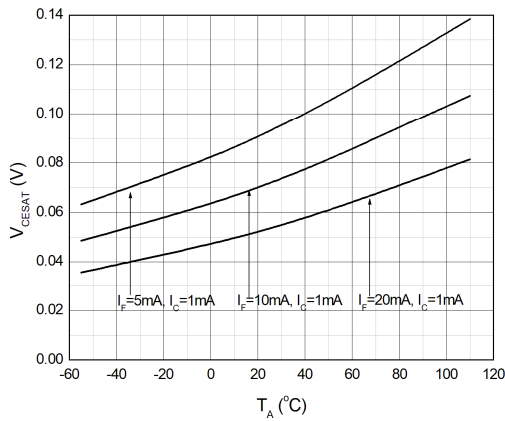
**Fig.7 Normalized Current Transfer Ratio vs. Forward Current**



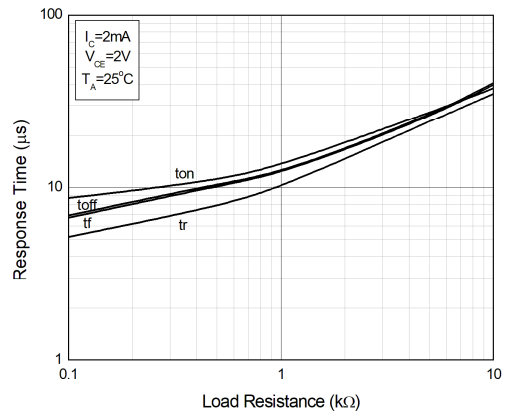
**Fig.8 Normalized Current Transfer Ratio vs. Ambient Temperature**



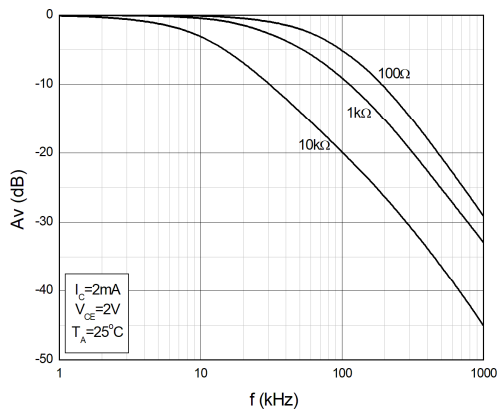
**Fig.9 Collector-emitter Saturation Voltage vs. Ambient Temperature**



**Fig.10 Switching Time vs. Load Resistance**

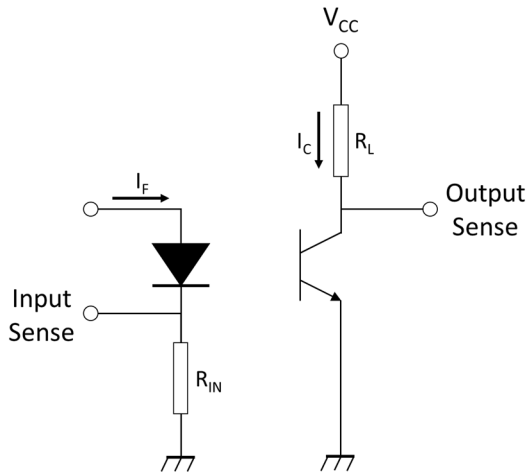


**Fig.11 Frequency Response**

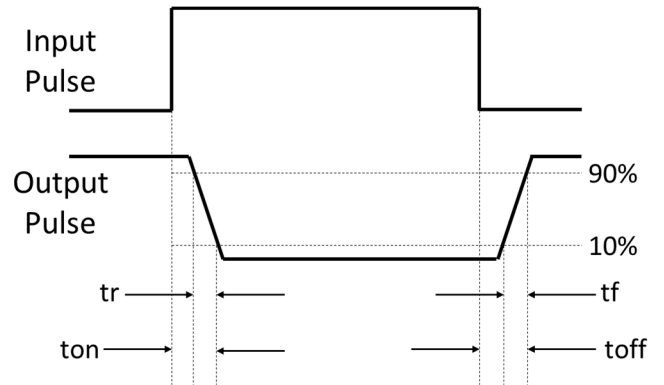


**TEST CIRCUITS**

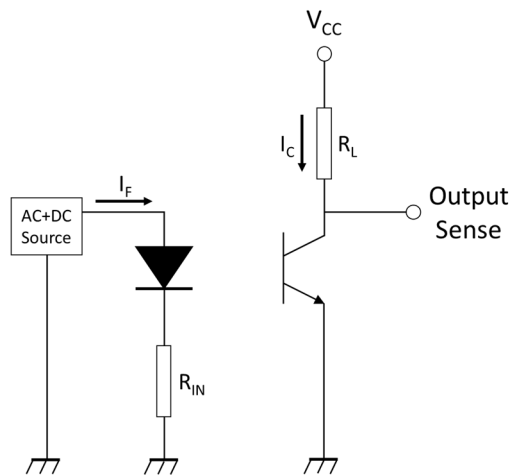
**Fig.12 Test Circuits of Response Time**



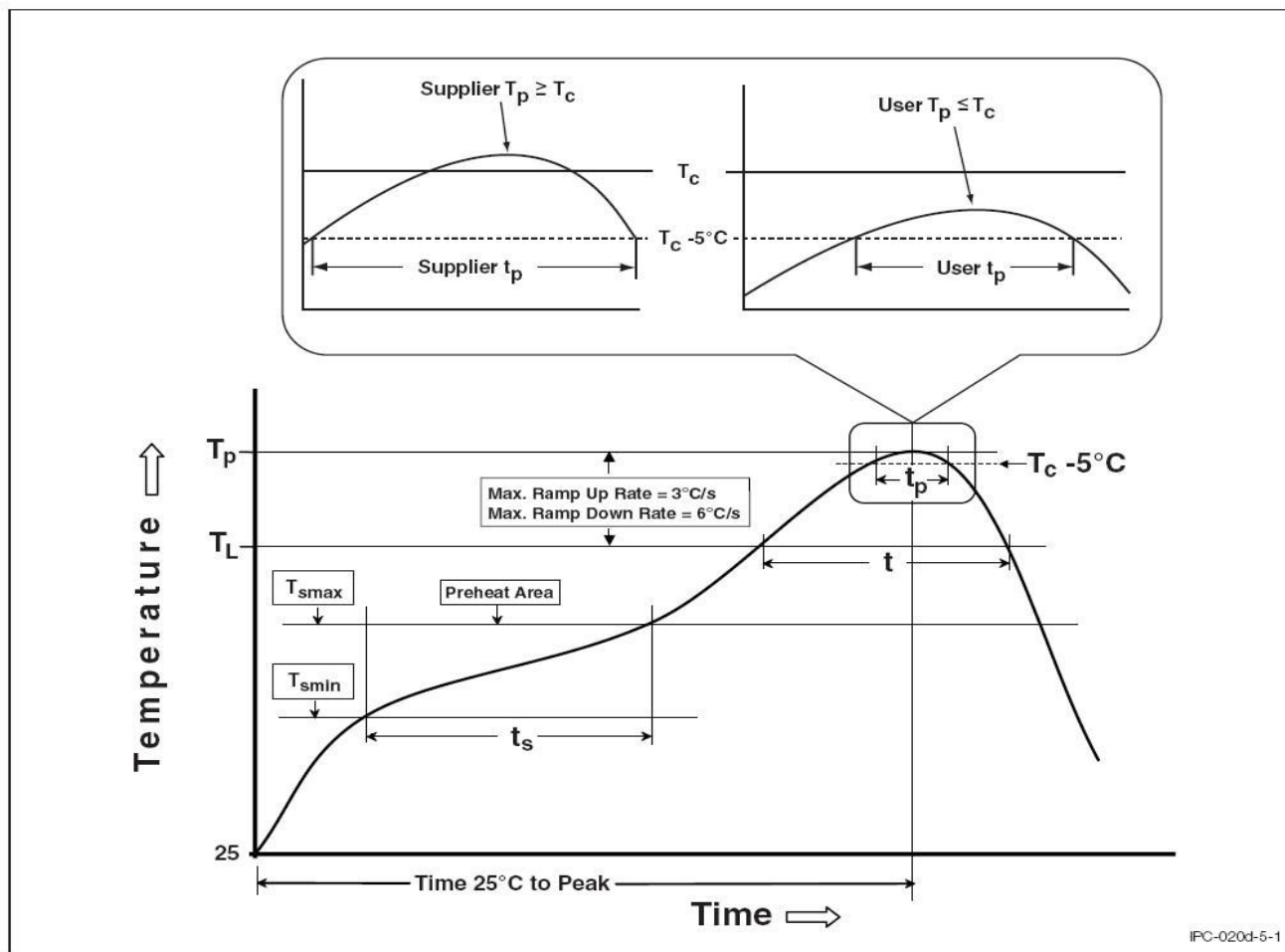
**Fig.13 Curves of Response Time**



**Fig.14 Test Circuits of Frequency Response**

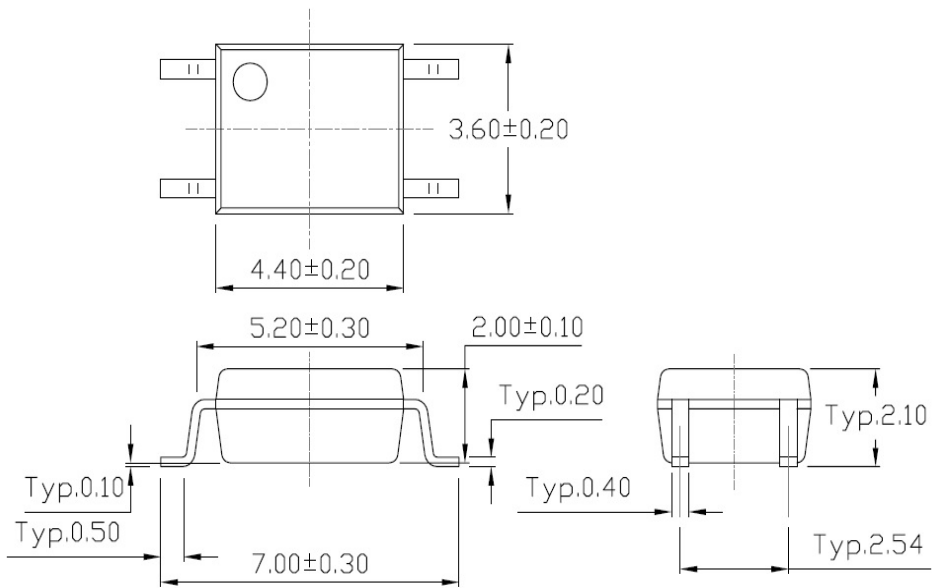


**REFLOW INFORMATION**  
**REFLOW PROFILE**



Profile Feature	Sn-Pb Assembly Profile	Pb-Free Assembly Profile
Temperature Min. (TsmIn)	100	150°C
Temperature Max. (Tsmax)	150	200°C
Time (ts) from (TsmIn to Tsmax)	60-120 seconds	60-120 seconds
Ramp-up Rate (tL to tP)	3°C/second max.	3°C/second max.
Liquidous Temperature (TL)	183°C	217°C
Time (tL) Maintained Above (TL)	60 – 150 seconds	60 – 150 seconds
Peak Body Package Temperature	235°C +0°C / -5°C	260°C +0°C / -5°C
Time (tP) within 5°C of 260°C	20 seconds	30 seconds
Ramp-down Rate (TP to TL)	6°C/second max	6°C/second max
Time 25°C to Peak Temperature	6 minutes max.	8 minutes max.

**PACKAGE DIMENSIONS (Dimensions in mm unless otherwise stated)**



**Marking**



"X" : Grading standard

"YWW" : Year week number