

Description

The D-PAK is designed for surface mounting using vapor phase, infrared, or wave soldering techniques. Power dissipation levels up to 1.5 watts are possible in typical surface mount applications.

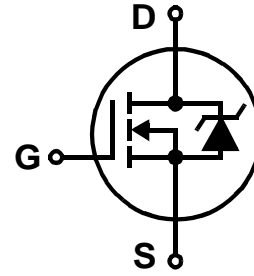

Features

V_{DS} (V) = 100V

I_D = 16A (V_{GS} = 10V)

$R_{DS(ON)}$ = 115m Ω (V_{GS} = 10V)

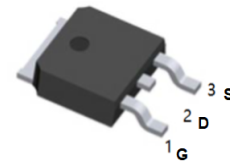

TO-252(DPAK) top view

Absolute Maximum Ratings

	Parameter	Max.	Units
I_D @ $T_C = 25^\circ\text{C}$	Continuous Drain Current, V_{GS} @ 10V	16	A
I_D @ $T_C = 100^\circ\text{C}$	Continuous Drain Current, V_{GS} @ 10V	12	
I_{DM}	Pulsed Drain Current ①⑥	60	
P_D @ $T_C = 25^\circ\text{C}$	Power Dissipation	79	W
	Linear Derating Factor	0.53	W/°C
V_{GS}	Gate-to-Source Voltage	± 20	V
E_{AS}	Single Pulse Avalanche Energy②⑥	150	mJ
I_{AR}	Avalanche Current①⑥	9.0	A
E_{AR}	Repetitive Avalanche Energy①⑥	7.9	mJ
dv/dt	Peak Diode Recovery dv/dt ③	5.0	V/ns
T_J	Operating Junction and	-55 to + 175	°C
T_{STG}	Storage Temperature Range		
	Soldering Temperature, for 10 seconds	300 (1.6mm from case)	

Thermal Resistance

	Parameter	Typ.	Max.	Units
$R_{\theta JC}$	Junction-to-Case	---	1.9	°C/W
$R_{\theta JA}$	Junction-to-Ambient (PCB mount) **	---	50	
$R_{\theta JA}$	Junction-to-Ambient	---	110	

Electrical Characteristics @ T_J = 25°C (unless otherwise specified)

	Parameter	Min.	Typ.	Max.	Units	Conditions
V _{(BR)DSS}	Drain-to-Source Breakdown Voltage	100	—	—	V	V _{GS} = 0V, I _D = 250μA
ΔV _{(BR)DSS/ΔT_J}	Breakdown Voltage Temp. Coefficient	—	0.12	—	V/°C	Reference to 25°C, I _D = 1mA
R _{DS(on)}	Static Drain-to-Source On-Resistance	—	—	0.115		V _{GS} = 10V, I _D = 10A ④
V _{GS(th)}	Gate Threshold Voltage	2.0	—	4.0	V	V _{DS} = V _{GS} , I _D = 250μA
g _{fs}	Forward Transconductance	6.4	—	—	S	V _{DS} = 50V, I _D = 9.0A⑥
I _{DSS}	Drain-to-Source Leakage Current	—	—	25	μA	V _{DS} = 100V, V _{GS} = 0V
		—	—	250		V _{DS} = 80V, V _{GS} = 0V, T _J = 150°C
I _{GSS}	Gate-to-Source Forward Leakage	—	—	100	nA	V _{GS} = 20V
	Gate-to-Source Reverse Leakage	—	—	-100		V _{GS} = -20V
Q _g	Total Gate Charge	—	—	44	nC	I _D = 9.0A
Q _{gs}	Gate-to-Source Charge	—	—	6.2		V _{DS} = 80V
Q _{gd}	Gate-to-Drain ("Miller") Charge	—	—	21		V _{GS} = 10V, See Fig. 6 and 13 ④⑥
t _{d(on)}	Turn-On Delay Time	—	6.4	—	ns	V _{DD} = 50V
t _r	Rise Time	—	27	—		I _D = 9.0A
t _{d(off)}	Turn-Off Delay Time	—	37	—		R _G = 12Ω
t _f	Fall Time	—	25	—		R _D = 5.5Ω, See Fig. 10 ④⑥
L _D	Internal Drain Inductance	—	4.5	—	nH	Between lead, 6mm (0.25in.) from package and center of die contact⑤
L _S	Internal Source Inductance	—	7.5	—		
C _{iss}	Input Capacitance	—	640	—	pF	V _{GS} = 0V
C _{oss}	Output Capacitance	—	160	—		V _{DS} = 25V
C _{rss}	Reverse Transfer Capacitance	—	88	—		f = 1.0MHz, See Fig. 5⑥

Source-Drain Ratings and Characteristics

	Parameter	Min.	Typ.	Max.	Units	Conditions
I _S	Continuous Source Current (Body Diode)	—	—	16	A	MOSFET symbol showing the integral reverse p-n junction diode.
I _{SM}	Pulsed Source Current (Body Diode) ①⑥	—	—	60		
V _{SD}	Diode Forward Voltage	—	—	1.3	V	T _J = 25°C, I _S = 9.0A, V _{GS} = 0V ④
t _{rr}	Reverse Recovery Time	—	130	190	ns	T _J = 25°C, I _F = 9.0A
Q _{rr}	Reverse Recovery Charge	—	650	970	nC	di/dt = 100A/μs ④⑥
t _{on}	Forward Turn-On Time	Intrinsic turn-on time is negligible (turn-on is dominated by L _S +L _D)				

Notes:

- ① Repetitive rating; pulse width limited by max. junction temperature. (See fig. 11)
- ② V_{DD} = 25V, starting T_J = 25°C, L = 3.1mH, R_G = 25Ω, I_{AS} = 9.0A. (See Figure 12)
- ③ I_{SD} ≤ 9.0A, di/dt ≤ 520A/μs, V_{DD} ≤ V_{(BR)DSS}, T_J ≤ 175°C
- ④ Pulse width ≤ 300μs; duty cycle ≤ 2%
- ⑤ This is applied for I-PAK, L_s of D-PAK is measured between lead and center of die contact
- ⑥ Uses IRF530N data and test conditions

** When mounted on 1" square PCB (FR-4 or G-10 Material) .
For recommended footprint and soldering techniques refer to application note #AN-994

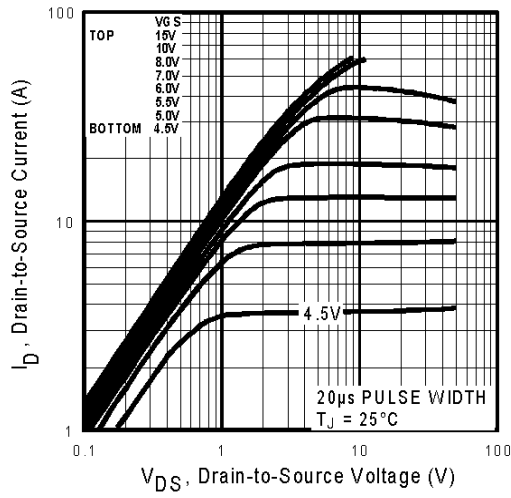

Fig 1. Typical Output Characteristics

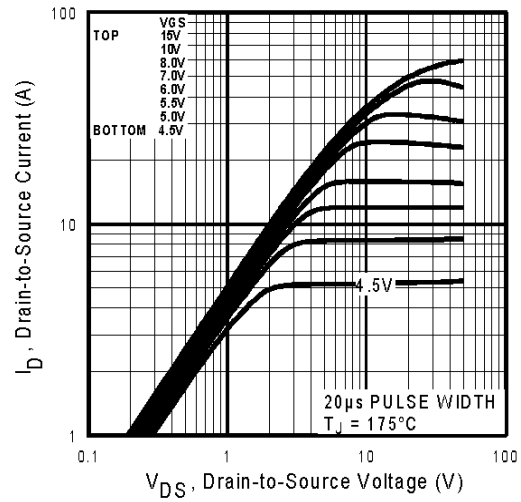

Fig 2. Typical Output Characteristics

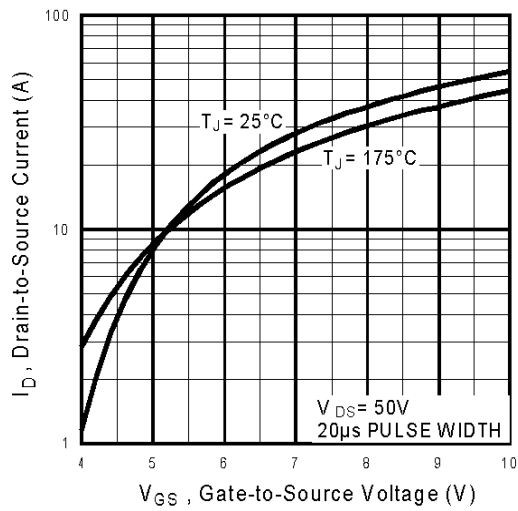

Fig 3. Typical Transfer Characteristics

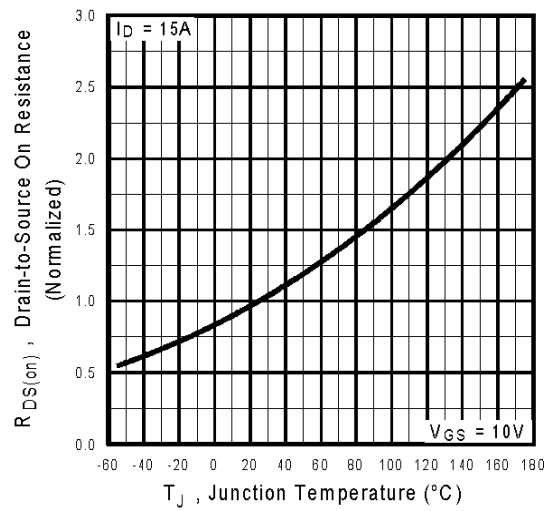

Fig 4. Normalized On-Resistance Vs. Temperature

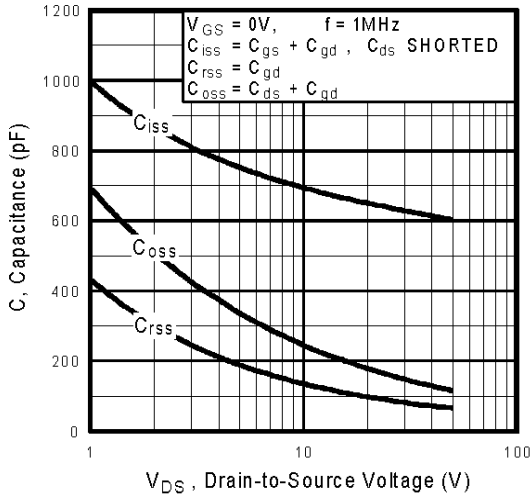

Fig 5. Typical Capacitance Vs. Drain-to-Source Voltage

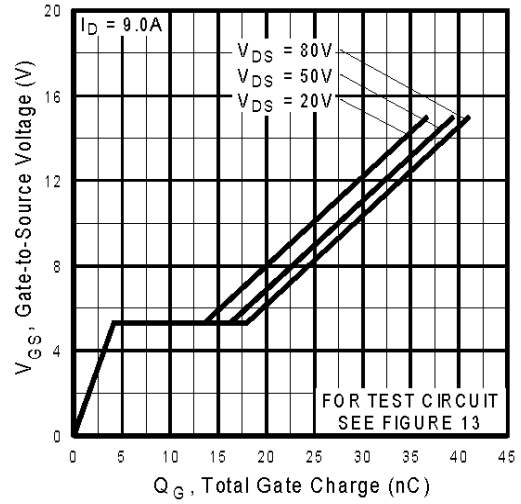

Fig 6. Typical Gate Charge Vs. Gate-to-Source Voltage

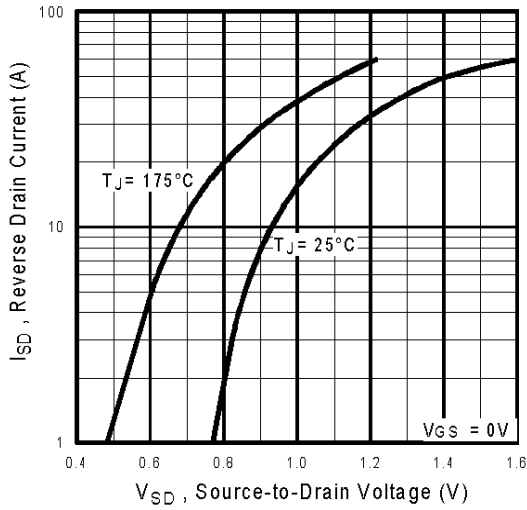

Fig 7. Typical Source-Drain Diode Forward Voltage

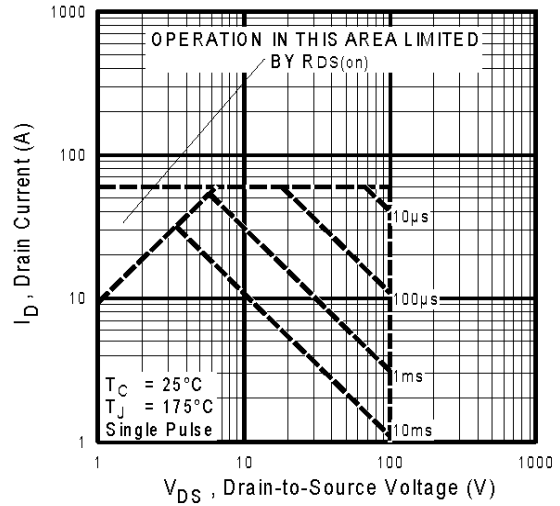

Fig 8. Maximum Safe Operating Area

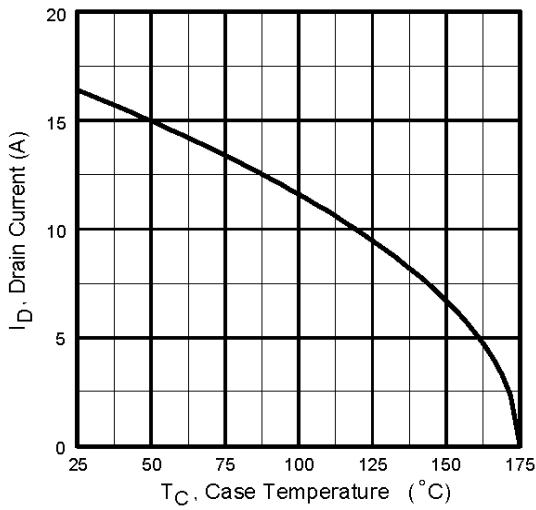

Fig 9. Maximum Drain Current Vs. Case Temperature

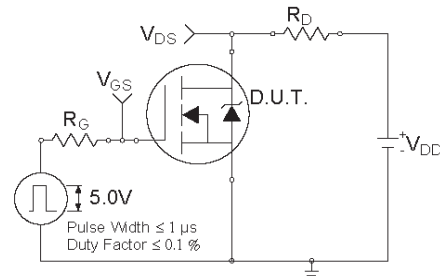

Fig 10a. Switching Time Test Circuit

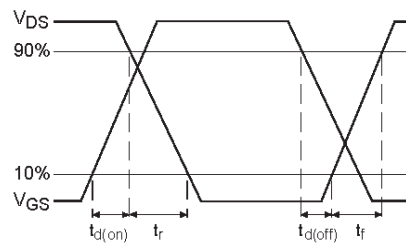

Fig 10b. Switching Time Waveforms

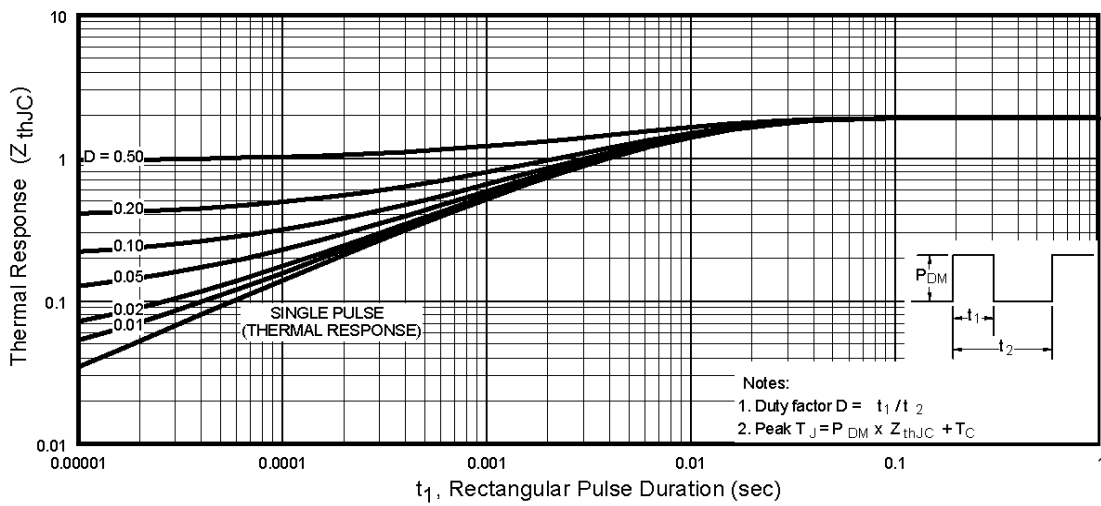

Fig 11. Maximum Effective Transient Thermal Impedance, Junction-to-Case

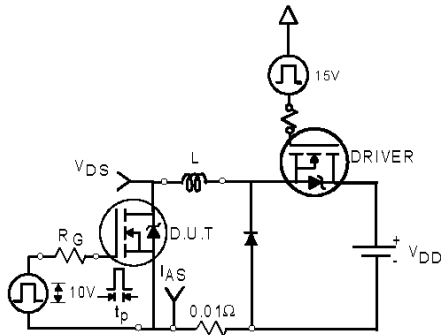

Fig 12a. Unclamped Inductive Test Circuit

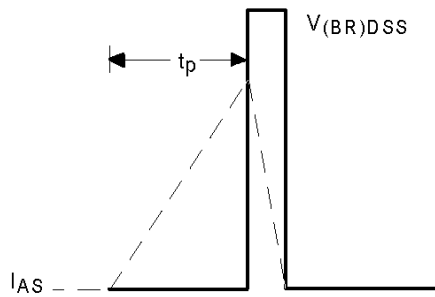

Fig 12b. Unclamped Inductive Waveforms

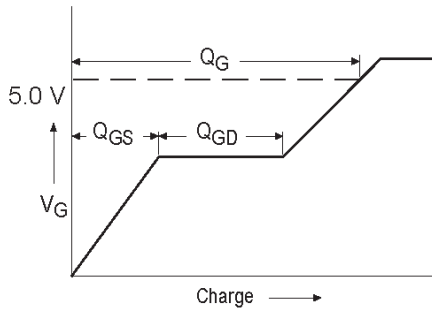

Fig 13a. Basic Gate Charge Waveform

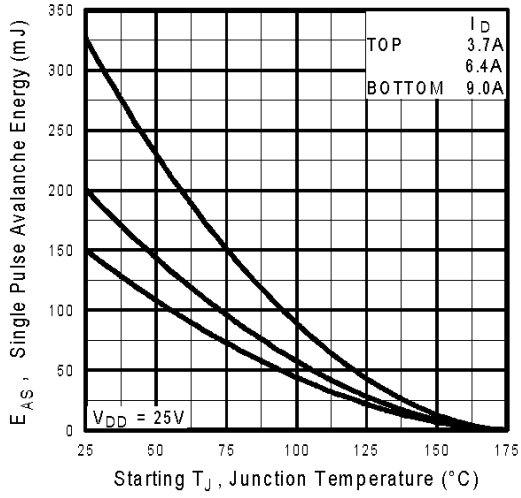

Fig 12c. Maximum Avalanche Energy Vs. Drain Current

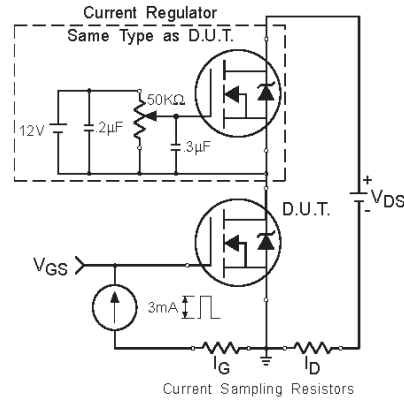
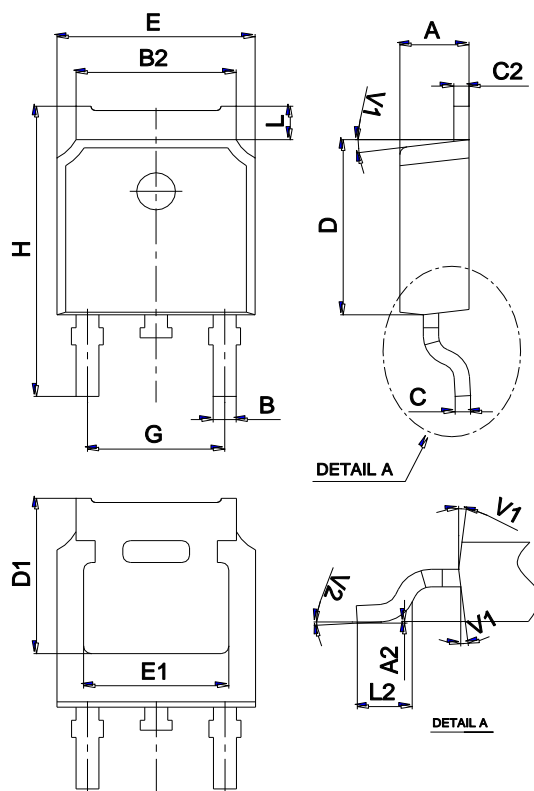

Fig 13b. Gate Charge Test Circuit

Package Mechanical Data TO-252



Ref.	Dimensions					
	Millimeters			Inches		
	Min.	Typ.	Max.	Min.	Typ.	Max.
A	2.10		2.50	0.083		0.098
A2	0		0.10	0		0.004
B	0.66		0.86	0.026		0.034
B2	5.18		5.48	0.202		0.216
C	0.40		0.60	0.016		0.024
C2	0.44		0.58	0.017		0.023
D	5.90		6.30	0.232		0.248
D1	5.30REF			0.209REF		
E	6.40		6.80	0.252		0.268
E1	4.63			0.182		
G	4.47		4.67	0.176		0.184
H	9.50		10.70	0.374		0.421
L	1.09		1.21	0.043		0.048
L2	1.35		1.65	0.053		0.065
V1		7°			7°	
V2	0°		6°	0°		6°

Ordering information

Order code	Package	Baseqty	Delivery mode
IRFR3910TR	TO-252	2500	Tape and reel