

## Features

- $V_{DS} (V) = 55V$
- $I_D = 44A (V_{GS}=10V)$
- $R_{DS(ON)} < 27m\Omega (V_{GS} = 10V)$

## Description

The D-PAK is designed for surface mounting using vapor phase, infrared, or wave soldering techniques. The straight lead version is for through-hole mounting applications. Power dissipation levels up to 1.5 watts are possible in typical surface mount applications.

- Ultra Low On-Resistance
- Fast Switching
- Fully Avalanche Rated
- Lead-Free

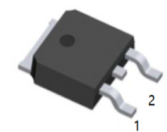

1.G 2.D 3.S  
TO-252(DPAK) top view

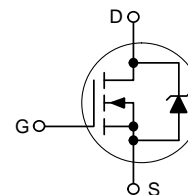

N-Channel

## Absolute Maximum Ratings

	Parameter	Max.	Units
$I_D @ T_C = 25^\circ C$	Continuous Drain Current, $V_{GS} @ 10V$	44 <sup>⑤</sup>	A
$I_D @ T_C = 100^\circ C$	Continuous Drain Current, $V_{GS} @ 10V$	31 <sup>⑤</sup>	
$I_{DM}$	Pulsed Drain Current <sup>①⑦</sup>	160	
$P_D @ T_C = 25^\circ C$	Power Dissipation	107	W
	Linear Derating Factor	0.71	W/°C
$V_{GS}$	Gate-to-Source Voltage	$\pm 20$	V
$E_{AS}$	Single Pulse Avalanche Energy <sup>②⑦</sup>	210	mJ
$I_{AR}$	Avalanche Current <sup>①⑦</sup>	25	A
$E_{AR}$	Repetitive Avalanche Energy <sup>①⑦</sup>	11	mJ
$dv/dt$	Peak Diode Recovery $dv/dt$ <sup>③</sup>	5.0	V/ns
$T_J$	Operating Junction and Storage Temperature Range	-55 to + 175	°C
$T_{STG}$			
	Soldering Temperature, for 10 seconds	300 (1.6mm from case )	

## Thermal Resistance

	Parameter	Typ.	Max.	Units
$R_{\theta JC}$	Junction-to-Case		1.4	°C/W
$R_{\theta JA}$	Junction-to-Ambient (PCB mount)		50	
$R_{\theta JA}$	Junction-to-Ambient		110	

### Electrical Characteristics @ T<sub>J</sub> = 25°C (unless otherwise specified)

	Parameter	Min.	Typ.	Max.	Units	Conditions
V <sub>(BR)DSS</sub>	Drain-to-Source Breakdown Voltage	55			V	V <sub>GS</sub> = 0V, I <sub>D</sub> = 250μA
ΔV <sub>(BR)DSS/ΔT<sub>J</sub></sub>	Breakdown Voltage Temp. Coefficient		0.055		V/°C	Reference to 25°C, I <sub>D</sub> = 1mA
R <sub>DS(on)</sub>	Static Drain-to-Source On-Resistance			27	mΩ	V <sub>GS</sub> = 10V, I <sub>D</sub> = 26A ④
V <sub>GS(th)</sub>	Gate Threshold Voltage	2.0		4.0	V	V <sub>DS</sub> = V <sub>GS</sub> , I <sub>D</sub> = 250μA
g <sub>fs</sub>	Forward Transconductance	17			S	V <sub>DS</sub> = 25V, I <sub>D</sub> = 25A ⑦
I <sub>DSS</sub>	Drain-to-Source Leakage Current			25	μA	V <sub>DS</sub> = 55V, V <sub>GS</sub> = 0V
				250	μA	V <sub>DS</sub> = 44V, V <sub>GS</sub> = 0V, T <sub>J</sub> = 150°C
I <sub>GSS</sub>	Gate-to-Source Forward Leakage			100	nA	V <sub>GS</sub> = 20V
	Gate-to-Source Reverse Leakage			-100	nA	V <sub>GS</sub> = -20V
Q <sub>g</sub>	Total Gate Charge			65	nC	I <sub>D</sub> = 25A
Q <sub>gs</sub>	Gate-to-Source Charge			12	nC	V <sub>DS</sub> = 44V
Q <sub>gd</sub>	Gate-to-Drain ("Miller") Charge			27	nC	V <sub>GS</sub> = 10V, See Fig. 6 and 13 ④ ⑦
t <sub>d(on)</sub>	Turn-On Delay Time		7.3		ns	V <sub>DD</sub> = 28V I <sub>D</sub> = 25A R <sub>G</sub> = 12Ω R <sub>D</sub> = 1.1Ω, See Fig. 10 ④ ⑦
t <sub>r</sub>	Rise Time		69			
t <sub>d(off)</sub>	Turn-Off Delay Time		47			
t <sub>f</sub>	Fall Time		60			
L <sub>D</sub>	Internal Drain Inductance		4.5		nH	Between lead, 6mm (0.25in.) from package and center of die contact ⑥
L <sub>S</sub>	Internal Source Inductance		7.5			
C <sub>iss</sub>	Input Capacitance		1300		pF	V <sub>GS</sub> = 0V V <sub>DS</sub> = 25V f = 1.0MHz, See Fig. 5 ⑦
C <sub>oss</sub>	Output Capacitance		410			
C <sub>rss</sub>	Reverse Transfer Capacitance		150			

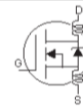

### Source-Drain Ratings and Characteristics

	Parameter	Min.	Typ.	Max.	Units	Conditions
I <sub>S</sub>	Continuous Source Current (Body Diode)			44 ⑤	A	MOSFET symbol showing the integral reverse p-n junction diode.
I <sub>SM</sub>	Pulsed Source Current (Body Diode) ① ⑦			160		
V <sub>SD</sub>	Diode Forward Voltage			1.3	V	T <sub>J</sub> = 25°C, I <sub>S</sub> = 22A, V <sub>GS</sub> = 0V ④
t <sub>rr</sub>	Reverse Recovery Time		65	98	ns	T <sub>J</sub> = 25°C, I <sub>F</sub> = 25A
Q <sub>rr</sub>	Reverse Recovery Charge		160	240	nC	di/dt = 100A/μs ④ ⑦
t <sub>on</sub>	Forward Turn-On Time	Intrinsic turn-on time is negligible (turn-on is dominated by L <sub>S</sub> +L <sub>D</sub> )				

#### Notes:

- ① Repetitive rating; pulse width limited by max. junction temperature. ( See fig. 11 )
- ② V<sub>DD</sub> = 25V, starting T<sub>J</sub> = 25°C, L = 470μH  
R<sub>G</sub> = 25Ω, I<sub>AS</sub> = 25A. (See Figure 12)
- ③ I<sub>SD</sub> ≤ 25A, di/dt ≤ 320A/μs, V<sub>DD</sub> ≤ V<sub>(BR)DSS</sub>,  
T<sub>J</sub> ≤ 175°C
- ④ Pulse width ≤ 300μs; duty cycle ≤ 2%.
- ⑤ Calculated continuous current based on maximum allowable junction temperature; Package limitation current = 20A
- ⑥ This is applied for I-PAK, L<sub>s</sub> of D-PAK is measured between lead and center of die contact
- ⑦ Uses IRFZ44N data and test conditions

TYPICAL CHARACTERISTICS (25 °C, unless otherwise noted)

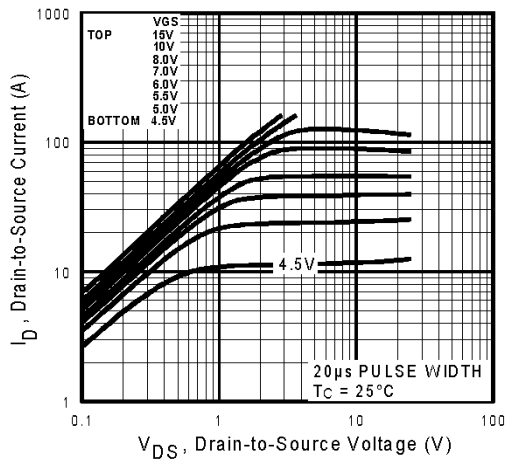

Fig 1. Typical Output Characteristics

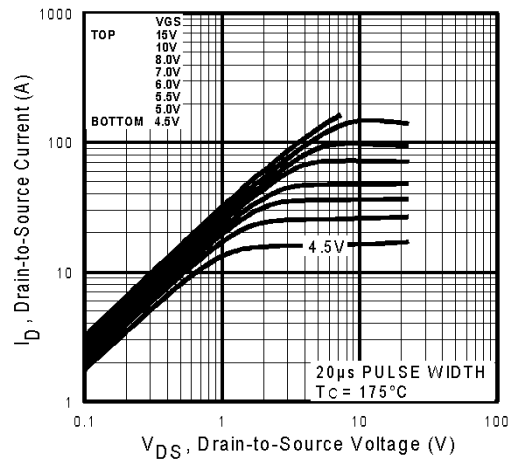

Fig 2. Typical Output Characteristics

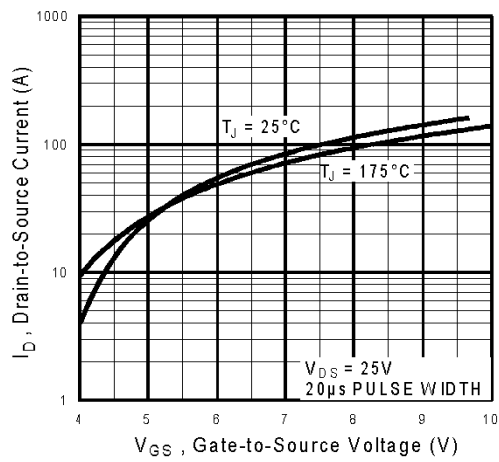

Fig 3. Typical Transfer Characteristics

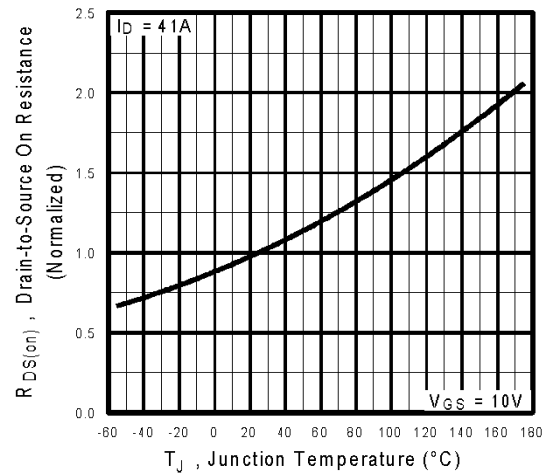

Fig 4. Normalized On-Resistance Vs. Temperature

TYPICAL CHARACTERISTICS (25 °C, unless otherwise noted)

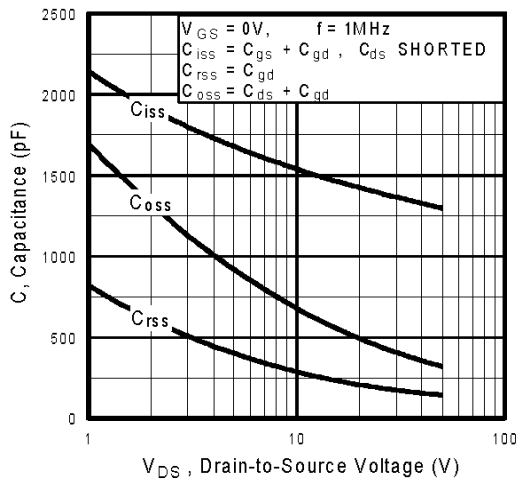

Fig 5. Typical Capacitance Vs. Drain-to-Source Voltage

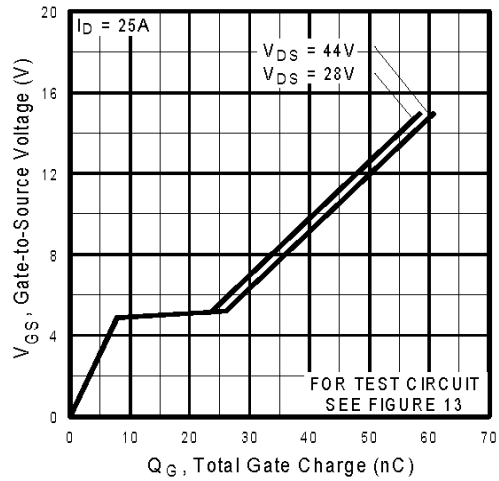

Fig 6. Typical Gate Charge Vs. Gate-to-Source Voltage

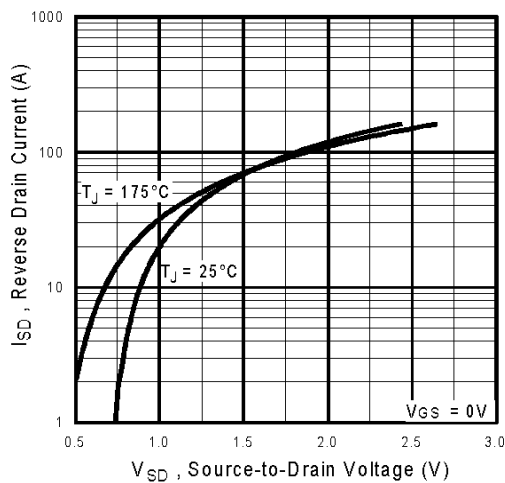

Fig 7. Typical Source-Drain Diode Forward Voltage

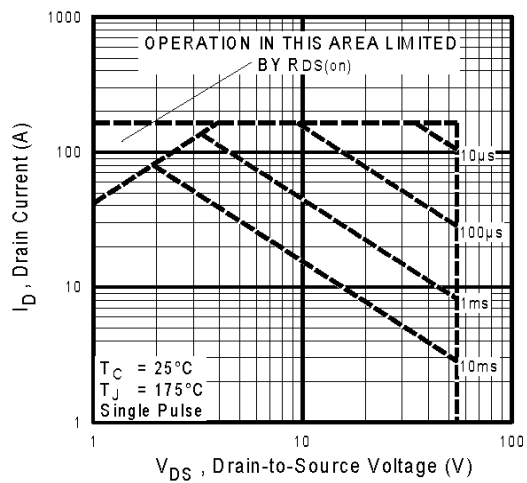

Fig 8. Maximum Safe Operating Area

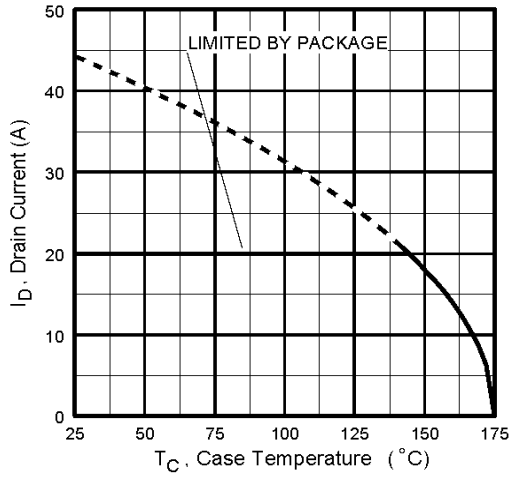

Fig 9. Maximum Drain Current Vs. Case Temperature

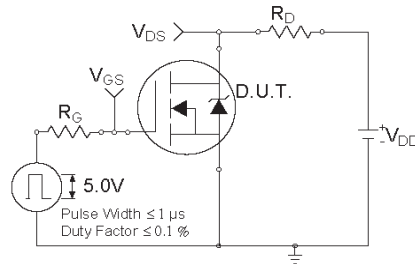

Fig 10a. Switching Time Test Circuit

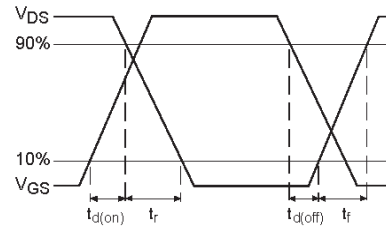

Fig 10b. Switching Time Waveforms

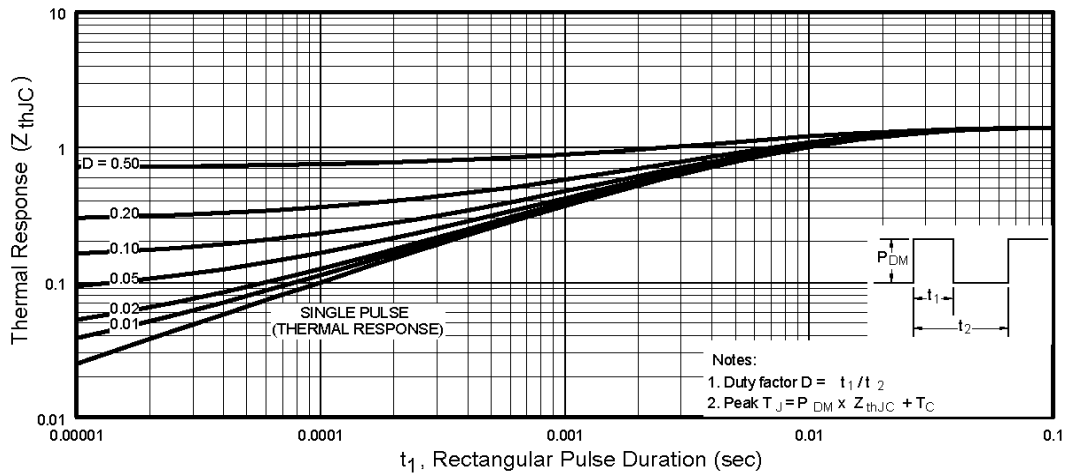

Fig 11. Maximum Effective Transient Thermal Impedance, Junction-to-Case

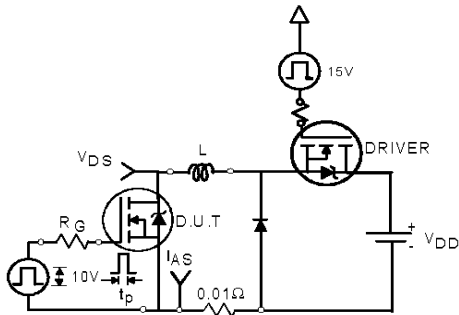

Fig 12a. Unclamped Inductive Test Circuit

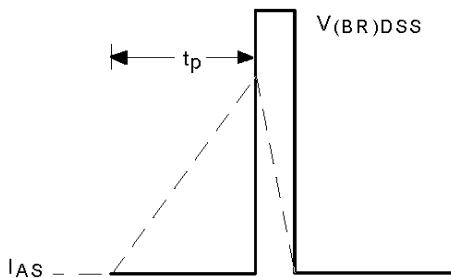

Fig 12b. Unclamped Inductive Waveforms

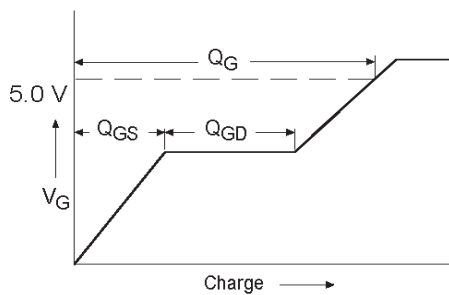

Fig 13a. Basic Gate Charge Waveform

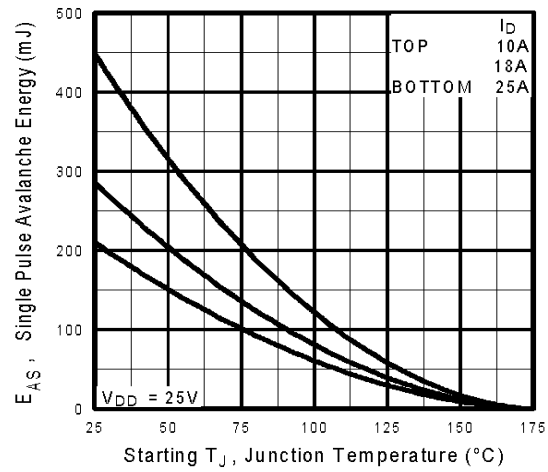

Fig 12c. Maximum Avalanche Energy Vs. Drain Current

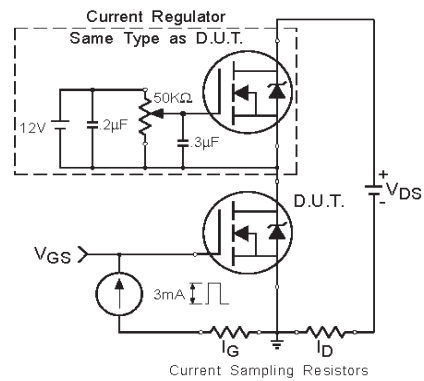
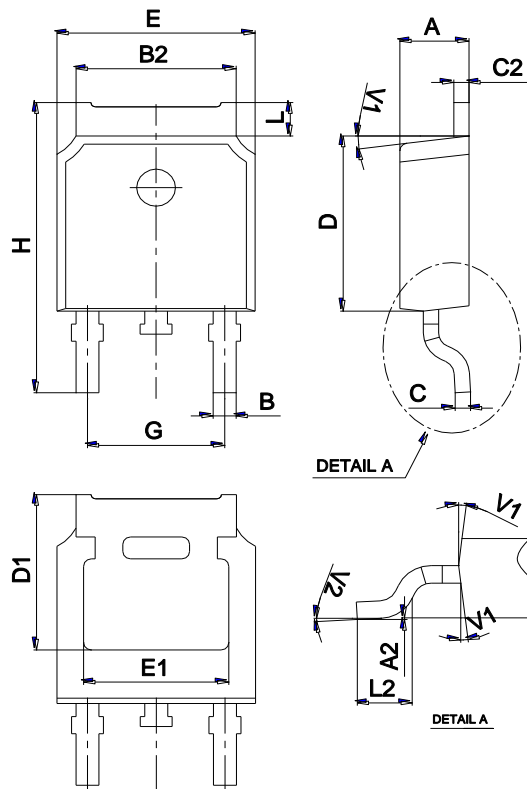

Fig 13b. Gate Charge Test Circuit

Package Mechanical Data TO-252



Ref.	Dimensions					
	Millimeters			Inches		
	Min.	Typ.	Max.	Min.	Typ.	Max.
A	2.10		2.50	0.083		0.098
A2	0		0.10	0		0.004
B	0.66		0.86	0.026		0.034
B2	5.18		5.48	0.202		0.216
C	0.40		0.60	0.016		0.024
C2	0.44		0.58	0.017		0.023
D	5.90		6.30	0.232		0.248
D1	5.30REF			0.209REF		
E	6.40		6.80	0.252		0.268
E1	4.63			0.182		
G	4.47		4.67	0.176		0.184
H	9.50		10.70	0.374		0.421
L	1.09		1.21	0.043		0.048
L2	1.35		1.65	0.053		0.065
V1		7°			7°	
V2	0°		6°	0°		6°

Marking

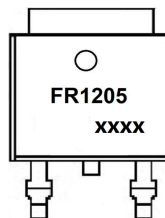

Ordering information

Order code	Package	Baseqty	Deliverymode
IRFR1205TR	TO-252	2500	Tape and reel