

OptiMOS™ 3 Power-Transistor

Features

- Fast switching MOSFET for SMPS
- Optimized technology for DC/DC converters
- Qualified according to JEDEC¹⁾ for target applications
- N-channel, logic level
- Excellent gate charge x $R_{DS(on)}$ product (FOM)
- Very low on-resistance $R_{DS(on)}$
- Avalanche rated
- Pb-free plating
- Halogen-free according to IEC61249-2-21 *

Product Summary

V_{DS}	30	V
$R_{DS(on),max}$	6	mΩ
I_D	50	A

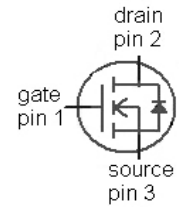

Type	IPD060N03L G	IPF060N03L G	IPS060N03L G	IPU060N03L G
Package	PG-TO252-3	PG-TO252-3-23	PG-TO251-3-11	PG-TO251-3
Marking	060N03L	060N03L	060N03L	060N03L

Maximum ratings, at $T_j=25\text{ °C}$, unless otherwise specified

Parameter	Symbol	Conditions	Value	Unit
Continuous drain current	I_D	$V_{GS}=10\text{ V}, T_C=25\text{ °C}$	50	A
		$V_{GS}=10\text{ V}, T_C=100\text{ °C}$	50	
		$V_{GS}=4.5\text{ V}, T_C=25\text{ °C}$	50	
		$V_{GS}=4.5\text{ V}, T_C=100\text{ °C}$	43	
Pulsed drain current ²⁾	$I_{D,pulse}$	$T_C=25\text{ °C}$	350	
Avalanche current, single pulse ³⁾	I_{AS}	$T_C=25\text{ °C}$	50	
Avalanche energy, single pulse	E_{AS}	$I_D=20\text{ A}, R_{GS}=25\text{ Ω}$	60	mJ
Reverse diode dv/dt	dv/dt	$I_D=50\text{ A}, V_{DS}=24\text{ V}, di/dt=200\text{ A/μs}, T_{j,max}=175\text{ °C}$	6	kV/μs
Gate source voltage	V_{GS}		±20	V

Maximum ratings, at $T_j=25\text{ °C}$, unless otherwise specified

Parameter	Symbol	Conditions	Value	Unit
Power dissipation	P_{tot}	$T_C=25\text{ °C}$	56	W
Operating and storage temperature	T_j, T_{stg}		-55 ... 175	°C
IEC climatic category; DIN IEC 68-1			55/175/56	

Parameter	Symbol	Conditions	Values			Unit
			min.	typ.	max.	

Thermal characteristics

Thermal resistance, junction - case	R_{thJC}		-	-	2.7	K/W
SMD version, device on PCB	R_{thJA}	minimal footprint	-	-	75	
		6 cm ² cooling area ⁴⁾	-	-	50	

Electrical characteristics, at $T_j=25\text{ °C}$, unless otherwise specified

Static characteristics

Drain-source breakdown voltage	$V_{(\text{BR})\text{DSS}}$	$V_{\text{GS}}=0\text{ V}, I_{\text{D}}=1\text{ mA}$	30	-	-	V
Gate threshold voltage	$V_{\text{GS(th)}}$	$V_{\text{DS}}=V_{\text{GS}}, I_{\text{D}}=250\text{ }\mu\text{A}$	1	-	2.2	
Zero gate voltage drain current	I_{DSS}	$V_{\text{DS}}=30\text{ V}, V_{\text{GS}}=0\text{ V}, T_j=25\text{ °C}$	-	0.1	1	μA
		$V_{\text{DS}}=30\text{ V}, V_{\text{GS}}=0\text{ V}, T_j=125\text{ °C}$	-	10	100	
Gate-source leakage current	I_{GSS}	$V_{\text{GS}}=20\text{ V}, V_{\text{DS}}=0\text{ V}$	-	10	100	nA
Drain-source on-state resistance ⁵⁾	$R_{\text{DS(on)}}$	$V_{\text{GS}}=4.5\text{ V}, I_{\text{D}}=30\text{ A}$	-	7.2	9	m Ω
		$V_{\text{GS}}=10\text{ V}, I_{\text{D}}=30\text{ A}$	-	5	6	
Gate resistance	R_{G}		-	1.4	-	Ω
Transconductance	g_{fs}	$ V_{\text{DS}} >2 I_{\text{D}} R_{\text{DS(on)max}}, I_{\text{D}}=30\text{ A}$	34	67	-	S

Parameter	Symbol	Conditions	Values			Unit
			min.	typ.	max.	

Dynamic characteristics

Input capacitance	C_{iss}	$V_{GS}=0\text{ V}, V_{DS}=15\text{ V},$ $f=1\text{ MHz}$	-	1700	2300	pF
Output capacitance	C_{oss}		-	640	850	
Reverse transfer capacitance	C_{rss}		-	35	52	
Turn-on delay time	$t_{d(on)}$	$V_{DD}=15\text{ V}, V_{GS}=10\text{ V},$ $I_D=30\text{ A}, R_G=1.6\ \Omega$	-	5	-	ns
Rise time	t_r		-	3	-	
Turn-off delay time	$t_{d(off)}$		-	20	-	
Fall time	t_f		-	3	-	

Gate Charge Characteristics⁶⁾

Gate to source charge	Q_{gs}	$V_{DD}=15\text{ V}, I_D=30\text{ A},$ $V_{GS}=0\text{ to }4.5\text{ V}$	-	5.6	-	nC
Gate charge at threshold	$Q_{g(th)}$		-	2.8	-	
Gate to drain charge	Q_{gd}		-	2.5	-	
Switching charge	Q_{sw}		-	5.3	-	
Gate charge total	Q_g		-	10.8	14.4	
Gate plateau voltage	$V_{plateau}$		-	3.2	-	
Gate charge total	Q_g	$V_{DD}=15\text{ V}, I_D=30\text{ A},$ $V_{GS}=0\text{ to }10\text{ V}$	-	22	30	nC
Gate charge total, sync. FET	$Q_{g(sync)}$	$V_{DS}=0.1\text{ V},$ $V_{GS}=0\text{ to }4.5\text{ V}$	-	9.4	-	
Output charge	Q_{oss}	$V_{DD}=15\text{ V}, V_{GS}=0\text{ V}$	-	17	-	

Reverse Diode

Diode continuous forward current	I_S	$T_C=25\text{ }^\circ\text{C}$	-	-	50	A
Diode pulse current	$I_{S,pulse}$		-	-	350	
Diode forward voltage	V_{SD}	$V_{GS}=0\text{ V}, I_F=30\text{ A},$ $T_j=25\text{ }^\circ\text{C}$	-	0.88	1.1	V
Reverse recovery charge	Q_{rr}	$V_R=15\text{ V}, I_F=I_S,$ $di_F/dt=400\text{ A}/\mu\text{s}$	-	-	10	nC

1 Power dissipation

$$P_{\text{tot}} = f(T_C)$$

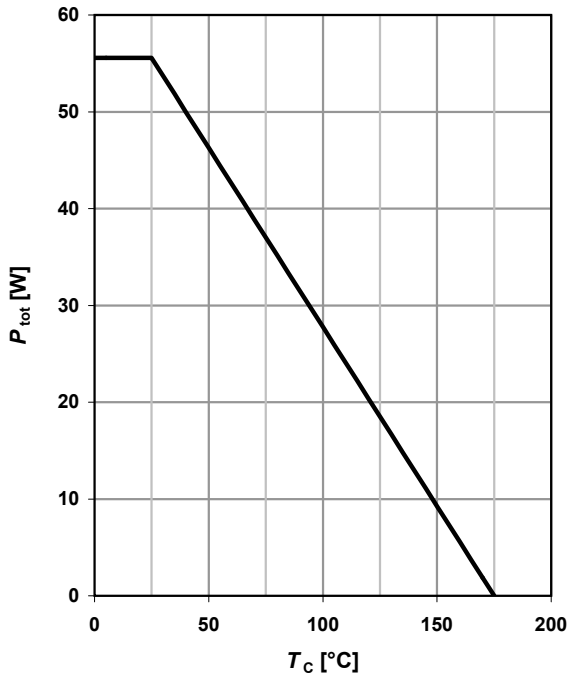

2 Drain current

$$I_D = f(T_C); V_{\text{GS}} \geq 10 \text{ V}$$

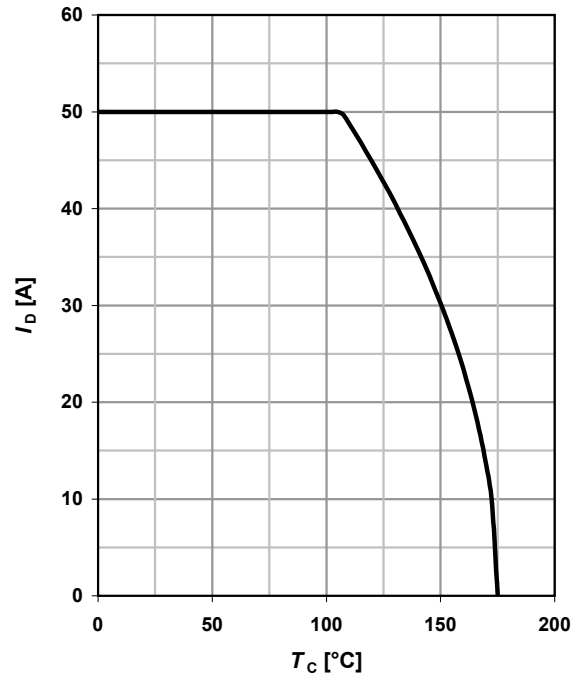

3 Safe operating area

$$I_D = f(V_{\text{DS}}); T_C = 25 \text{ °C}; D = 0$$

parameter: t_p

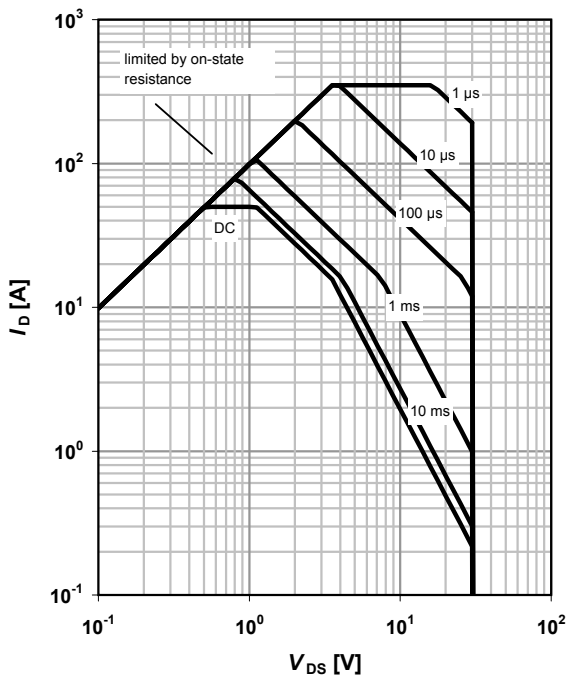

4 Max. transient thermal impedance

$$Z_{\text{thJC}} = f(t_p)$$

parameter: $D = t_p / T$

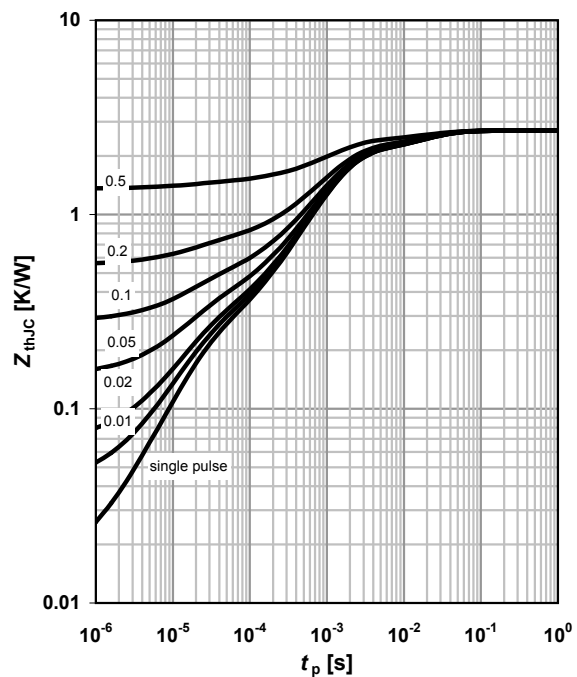

5 Typ. output characteristics

$$I_D = f(V_{DS}); T_j = 25\text{ }^\circ\text{C}$$

parameter: V_{GS}

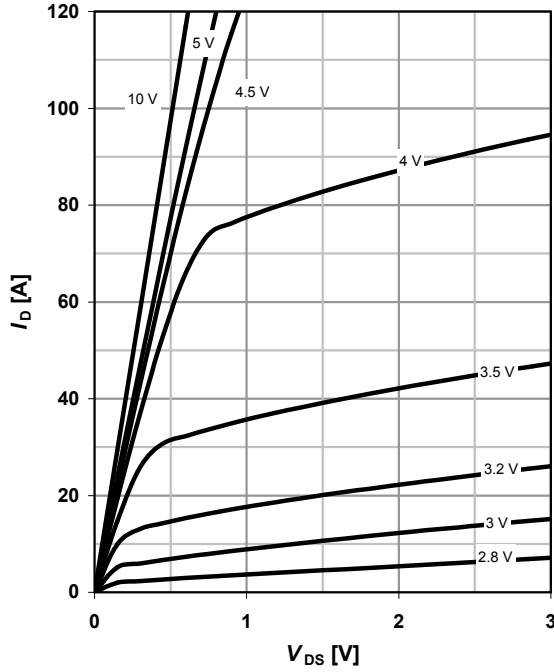

6 Typ. drain-source on resistance

$$R_{DS(on)} = f(I_D); T_j = 25\text{ }^\circ\text{C}$$

parameter: V_{GS}

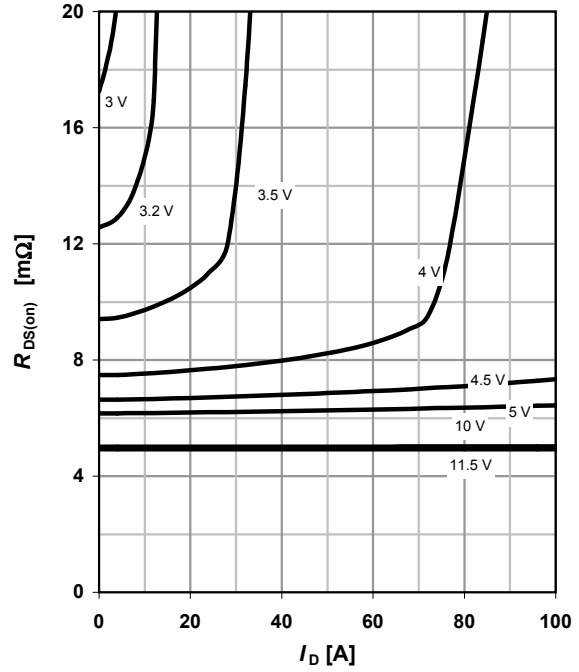

7 Typ. transfer characteristics

$$I_D = f(V_{GS}); |V_{DS}| > 2|I_D|R_{DS(on)max}$$

parameter: T_j

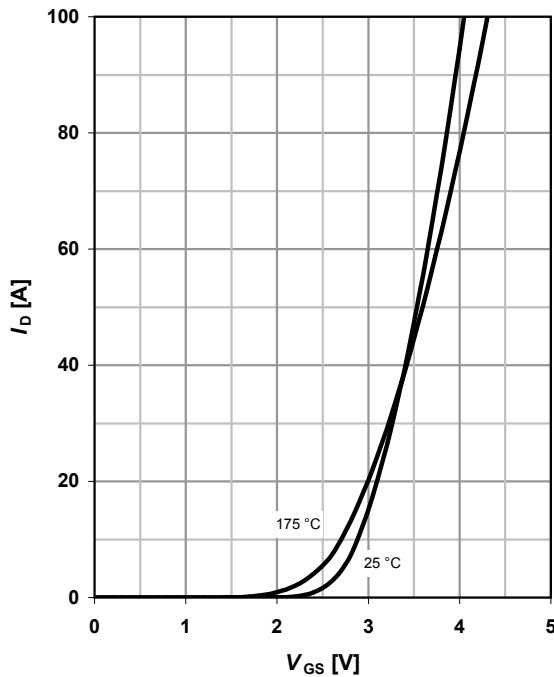

8 Typ. forward transconductance

$$g_{fs} = f(I_D); T_j = 25\text{ }^\circ\text{C}$$

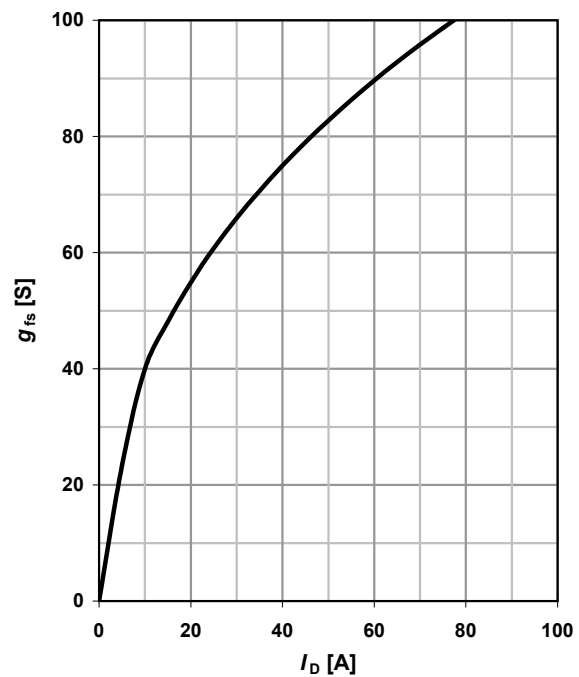

9 Drain-source on-state resistance

$$R_{DS(on)} = f(T_j); I_D = 30 \text{ A}; V_{GS} = 10 \text{ V}$$

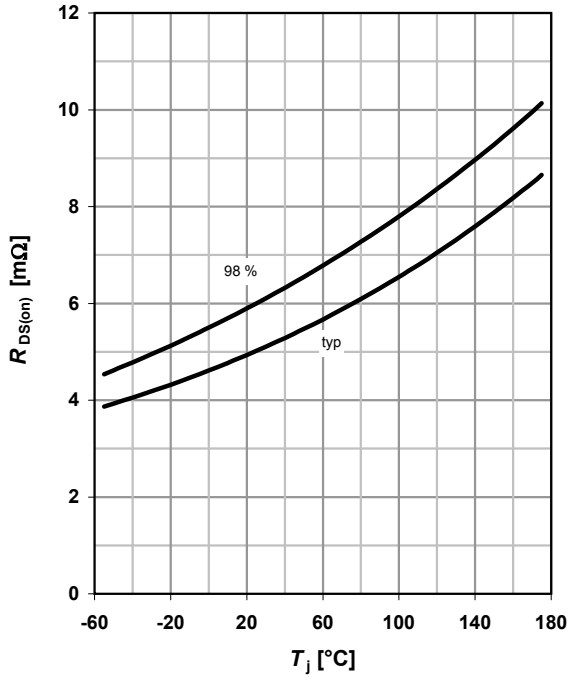

10 Typ. gate threshold voltage

$$V_{GS(th)} = f(T_j); V_{GS} = V_{DS}; I_D = 250 \mu\text{A}$$

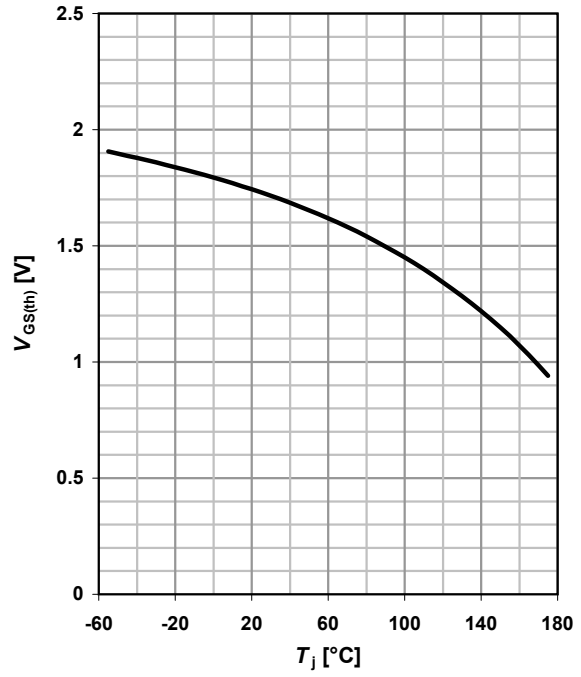

11 Typ. capacitances

$$C = f(V_{DS}); V_{GS} = 0 \text{ V}; f = 1 \text{ MHz}$$

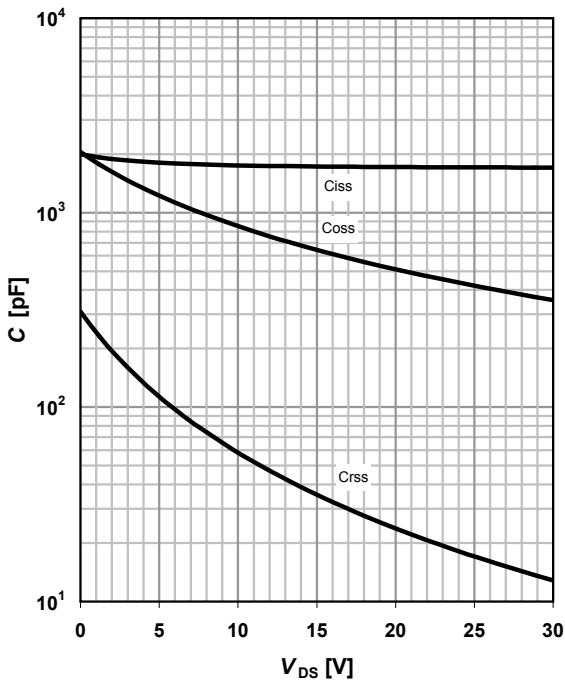

12 Forward characteristics of reverse diode

$$I_F = f(V_{SD})$$

parameter: T_j

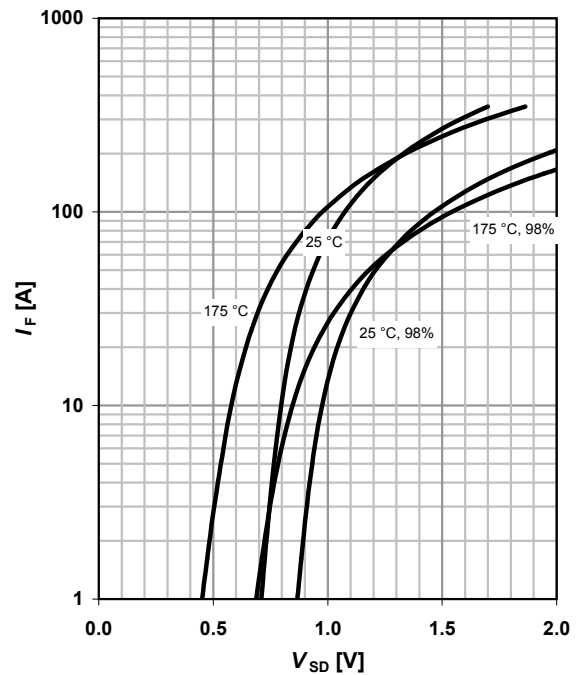

13 Avalanche characteristics

$$I_{AS} = f(t_{AV}); R_{GS} = 25 \Omega$$

parameter: $T_{j(\text{start})}$

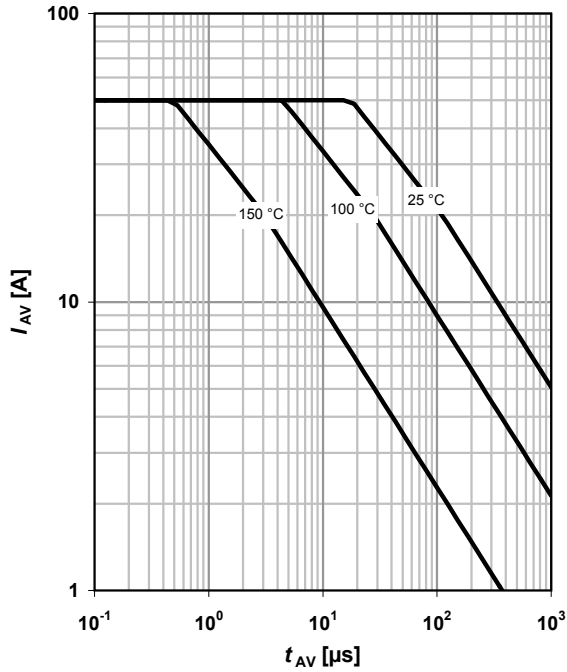

14 Typ. gate charge

$$V_{GS} = f(Q_{\text{gate}}); I_D = 30 \text{ A pulsed}$$

parameter: V_{DD}

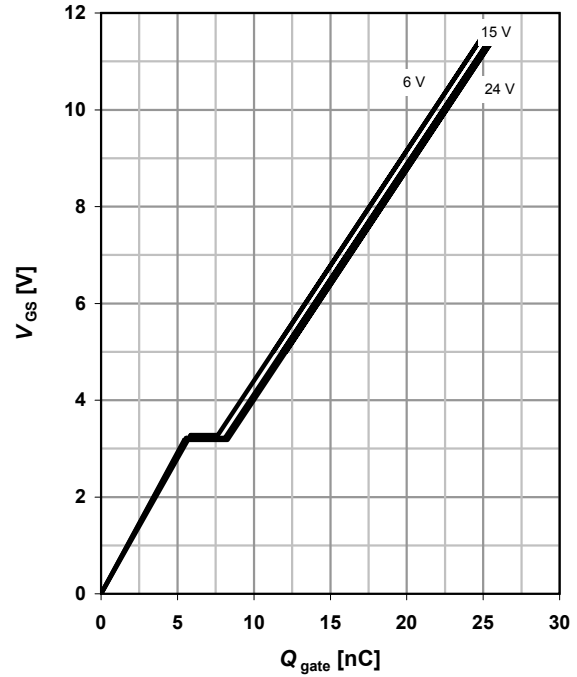

15 Drain-source breakdown voltage

$$V_{BR(DSS)} = f(T_j); I_D = 1 \text{ mA}$$

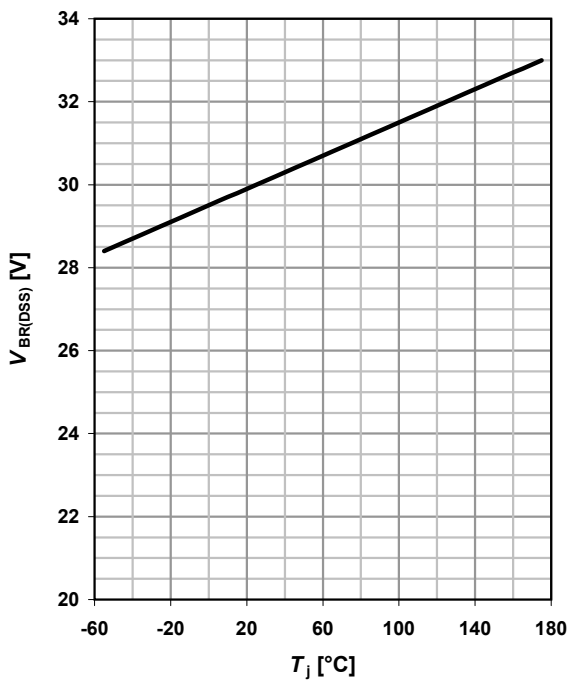

16 Gate charge waveforms

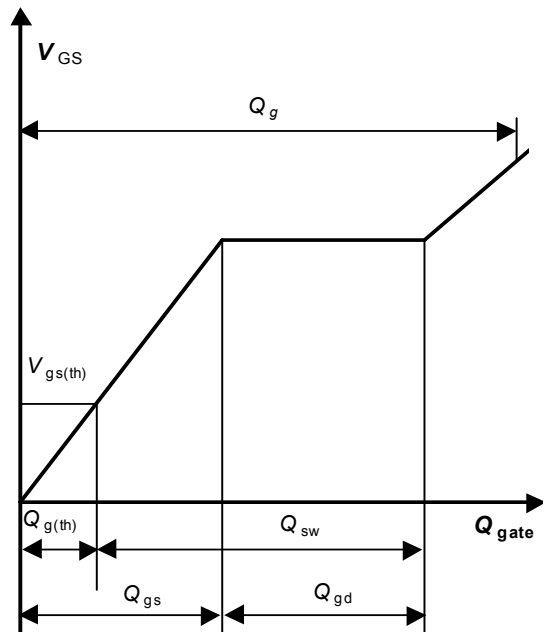

Package Outline

PG-TO252-3

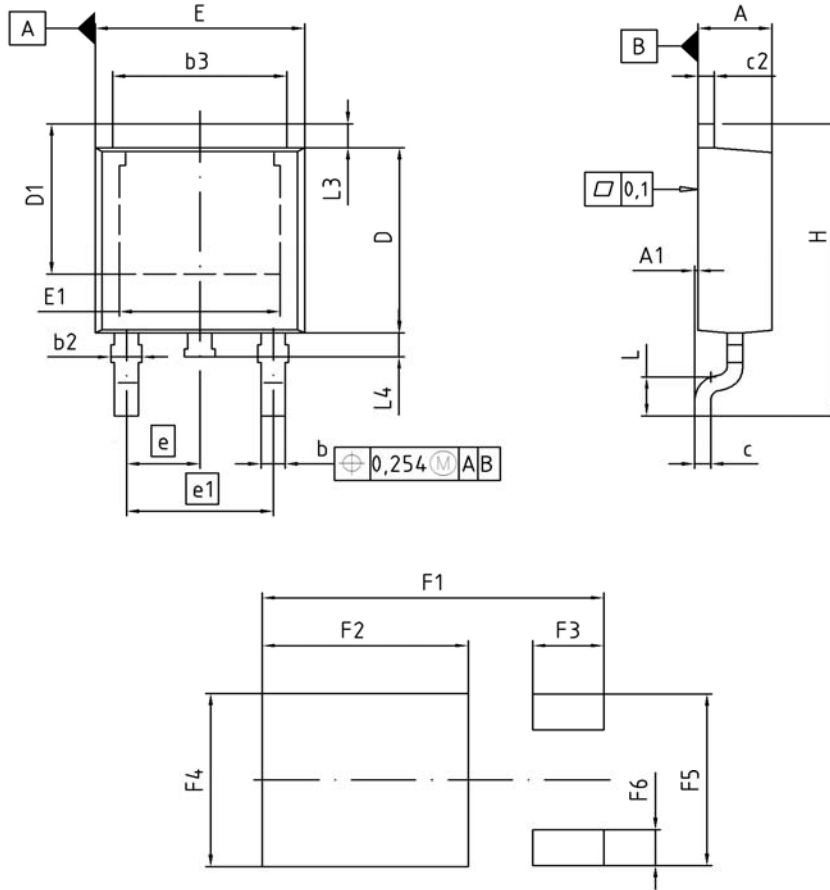

DIM	MILLIMETERS		INCHES	
	MIN	MAX	MIN	MAX
A	2.16	2.41	0.085	0.095
A1	0.00	0.15	0.000	0.006
b	0.64	0.89	0.025	0.035
b2	0.65	1.15	0.026	0.045
b3	5.00	5.50	0.197	0.217
c	0.46	0.60	0.018	0.024
c2	0.46	0.98	0.018	0.039
D	5.97	6.22	0.235	0.245
D1	5.02	5.84	0.198	0.230
E	6.40	6.73	0.252	0.265
E1	4.70	5.21	0.185	0.205
e	2.29		0.090	
e1	4.57		0.180	
N	3		3	
H	9.40	10.48	0.370	0.413
L	1.18	1.70	0.046	0.067
L3	0.90	1.25	0.035	0.049
L4	0.51	1.00	0.020	0.039
F1	10.50	10.70	0.413	0.421
F2	6.30	6.50	0.248	0.256
F3	2.10	2.30	0.083	0.091
F4	5.70	5.90	0.224	0.232
F5	5.66	5.86	0.223	0.231
F6	1.10	1.30	0.043	0.051

DOCUMENT NO.
Z8B00003328

SCALE 0 2.0 4mm

EUROPEAN PROJECTION

ISSUE DATE
19-10-2007

REVISION
03

Package Outline

PG-TO252-3-23

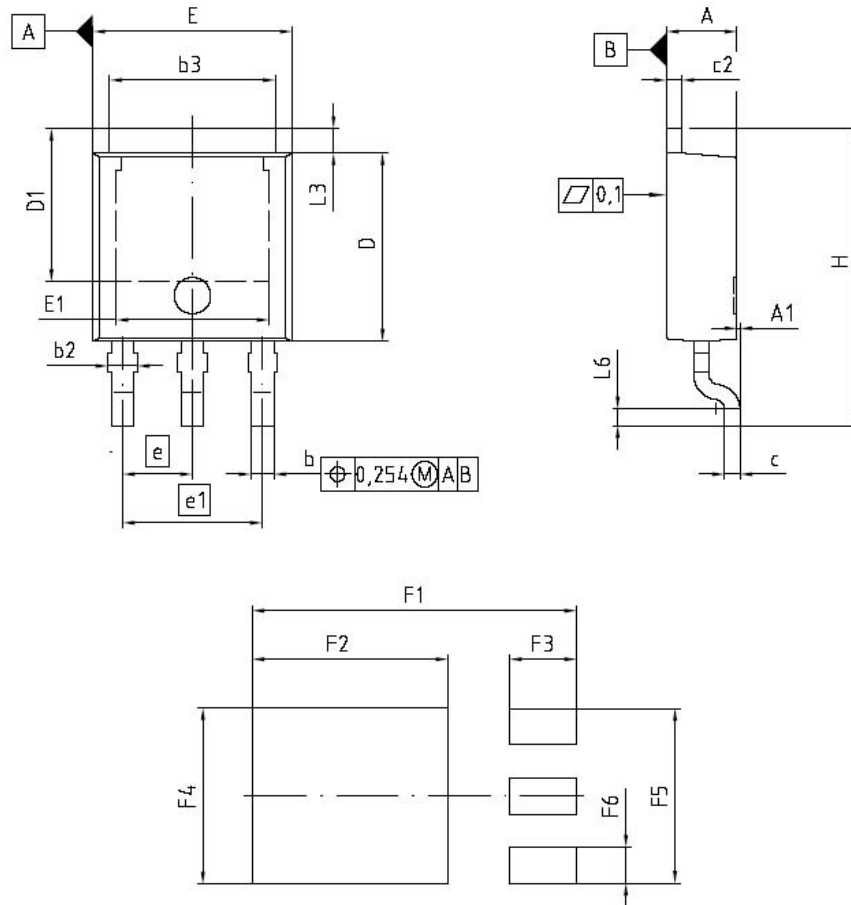

DIM	MILLIMETERS		INCHES	
	MIN	MAX	MIN	MAX
A	2.159	2.413	0.085	0.095
A1	0.000	0.150	0.000	0.006
b	0.635	0.889	0.025	0.035
b2	0.650	1.150	0.026	0.045
b3	5.004	5.500	0.197	0.217
c	0.457	0.580	0.018	0.023
c2	0.460	0.980	0.018	0.039
D	5.969	6.223	0.235	0.245
D1	5.020	5.842	0.198	0.230
E	6.400	6.731	0.252	0.265
E1	4.850	5.207	0.191	0.205
e	2.286		0.090	
e1	4.572		0.180	
N	3		3	
H	9.400	10.480	0.370	0.413
L3	0.900	1.143	0.035	0.045
L4	0.584	0.950	0.023	0.037
L6	0.510	0.696	0.020	0.027
F1	10.500	10.700	0.413	0.421
F2	6.300	6.500	0.248	0.256
F3	2.100	2.300	0.083	0.091
F4	5.700	5.900	0.224	0.232
F5	5.660	5.860	0.222	0.231
F6	1.100	1.300	0.043	0.051

REFERENCE
- / -

SCALE

4mm

EUROPEAN PROJECTION

ISSUE DATE
21-09-2005

FILE
TO252_2

Package Outline

PG-TO251-3-11

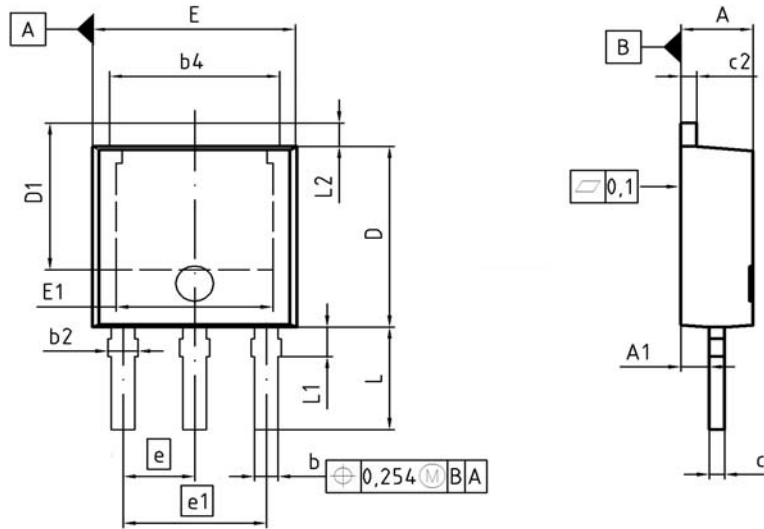

DIM	MILLIMETERS		INCHES	
	MIN	MAX	MIN	MAX
A	2.18	2.39	0.086	0.094
A1	0.80	1.14	0.031	0.045
b	0.64	0.89	0.025	0.035
b2	0.65	1.15	0.026	0.045
b4	4.95	5.50	0.195	0.217
c	0.46	0.58	0.018	0.023
c2	0.46	0.89	0.018	0.035
D	5.97	6.22	0.235	0.245
D1	5.04	5.44	0.198	0.214
E	6.35	6.73	0.250	0.265
E1	4.90	5.10	0.193	0.201
e	2.29		0.090	
e1	4.57		0.180	
N	3		3	
L	3.40	3.60	0.134	0.142
L1	0.90	1.10	0.035	0.043
L2	0.90	1.10	0.035	0.043

DOCUMENT NO.
Z8B00003329

SCALE 4mm

EUROPEAN PROJECTION

ISSUE DATE
17-01-2008

REVISION
03

Package Outline

PG-TO251-3

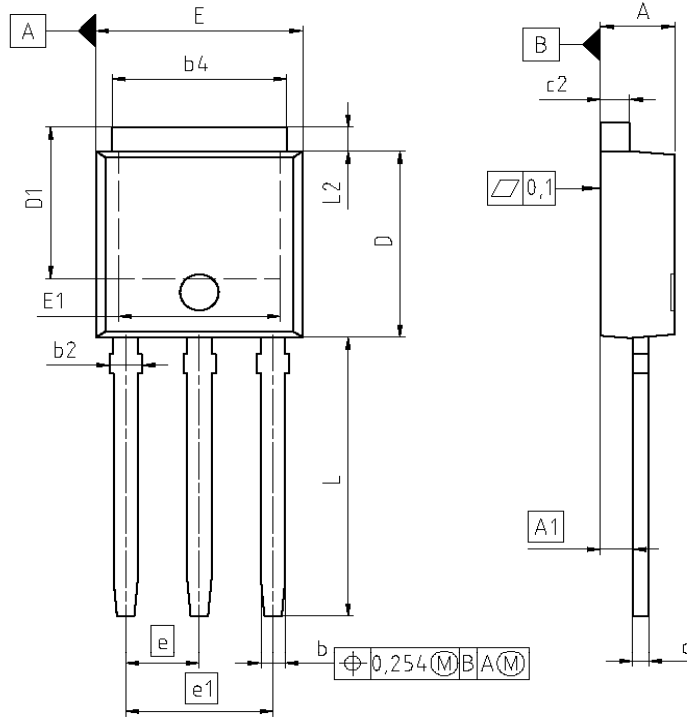

DIM	MILLIMETERS		INCHES	
	MIN	MAX	MIN	MAX
A	2.16	2.41	0.085	0.095
A1	0.90	1.12	0.035	0.044
b	0.64	0.89	0.025	0.035
b2	0.85	1.15	0.026	0.045
b4	5.00	5.50	0.197	0.217
c	0.46	0.60	0.018	0.024
c2	0.46	0.98	0.018	0.039
D	5.97	6.22	0.235	0.245
D1	5.10	6.12	0.201	0.241
E	6.40	6.73	0.252	0.265
E1	4.70	5.21	0.185	0.205
e	2.29		0.090	
e1	4.57		0.180	
N	3		3	
L	8.90	9.60	0.350	0.378
L2	0.90	1.25	0.035	0.049

DOCUMENT NO.
Z8B00003330

SCALE
0 2.0 4mm

EUROPEAN PROJECTION

ISSUE DATE
30-03-2007

REVISION
02