

BSS84 P-CHANNEL MOSFET

$V_{(BR)DSS}$	$R_{DS(on)MAX}$	I_D
-50V	8Ω@-10V	-0.13A
	10Ω@-5V	

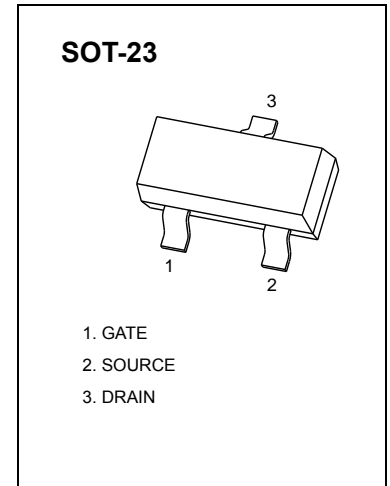

DESCRIPTION

These miniature surface mount MOSFETs reduce power loss conserve energy, making this device ideal for use in small power management circuitry.

FEATURE

- Energy Efficient
- Low Threshold Voltage
- High-speed Switching
- Miniature Surface Mount Package Saves Board Space

APPLICATION

- DC-DC converters, load switching, power management in portable and battery-powered products such as computers, printers, cellular and cordless telephones.

MARKING

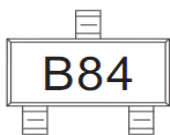

Equivalent Circuit

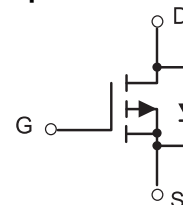

MAXIMUM RATINGS ($T_a=25^{\circ}C$ unless otherwise noted)

Parameter	Symbol	Value	Unit
Drain-Source Voltage	V_{DS}	-50	V
Gate-Source Voltage	V_{GS}	±20	V
Continuous Drain Current	I_D	-0.13	A
Pulsed Drain Current (note 1) @tp <10 μs	I_{DM}	-0.52	A
Power Dissipation	P_D	225	mW
Thermal Resistance from Junction to Ambient (note 2)	$R_{\theta JA}$	556	°C/W
Junction Temperature	T_J	150	°C
Storage Temperature	T_{STG}	-55~+150	°C
Maximum Lead Temperature for Soldering Purposes , Duration for 5 Seconds	T_L	260	°C

$T_a=25^\circ\text{C}$ unless otherwise specified

Parameter	Symbol	Test Condition	Min	Typ	Max	Unit
STATIC CHARACTERISTICS						
Drain-source breakdown voltage	$V_{(BR)DSS}$	$V_{GS} = 0V, I_D = -250\mu A$	-50			V
Zero gate voltage drain current	I_{DSS}	$V_{DS} = -50V, V_{GS} = 0V$			-15	μA
		$V_{DS} = -25V, V_{GS} = 0V$			-0.1	μA
Gate-body leakage current	I_{GSS}	$V_{GS} = \pm 20V, V_{DS} = 0V$			± 5	μA
Gate threshold voltage (note 3)	$V_{GS(th)}$	$V_{DS} = V_{GS}, I_D = -250\mu A$	-0.9	-1.6	-2	V
Drain-source on-resistance (note 3)	$R_{DS(on)}$	$V_{GS} = -5V, I_D = -0.1A$		5.8	10	Ω
		$V_{GS} = -10V, I_D = -0.1A$		4.5	8	Ω
Forward transconductance (note 1)	g_{FS}	$V_{DS} = -25V; I_D = -100mA$	50			mS
DYNAMIC CHARACTERISTICS (note 4)						
Input capacitance	C_{iss}	$V_{DS} = 5V, V_{GS} = 0V, f = 1MHz$		30		pF
Output capacitance	C_{oss}			10		pF
Reverse transfer capacitance	C_{rss}			5		pF
SWITCHING CHARACTERISTICS (note 4)						
Turn-on delay time	$t_{d(on)}$	$V_{DD} = -15V,$ $R_L = 50\Omega, I_D = -2.5A$		2.5		ns
Turn-on rise time	t_r			1		ns
Turn-off delay time	$t_{d(off)}$			16		ns
Turn-off fall time	t_f			8		ns
SOURCE-DRAIN DIODE CHARACTERISTICS						
Continuous Current	I_S				-0.13	A
Pulsed Current	I_{SM}				-0.52	A
Diode forward voltage (note 3)	V_{SD}	$I_S = -0.13A, V_{GS} = 0V$			-2.2	V

Notes :

1. Repetitive rating : Pulse width limited by junction temperature.
2. Surface mounted on FR4 board , $t \leq 10s$.
3. Pulse Test : Pulse Width $\leq 300\mu s$, Duty Cycle $\leq 2\%$.
4. Guaranteed by design, not subject to producing.

Output Characteristics

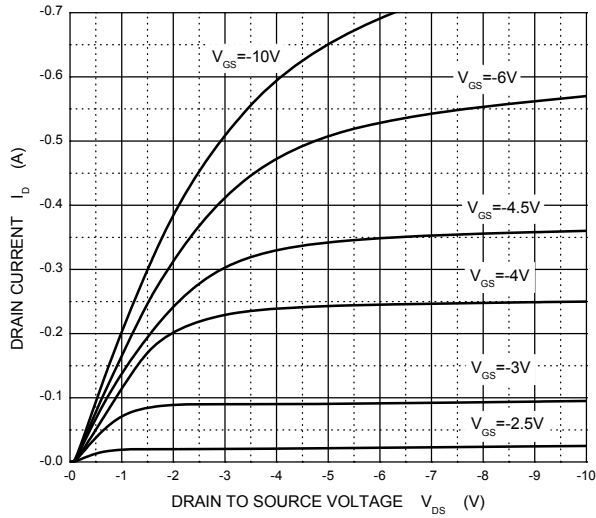

Transfer Characteristics

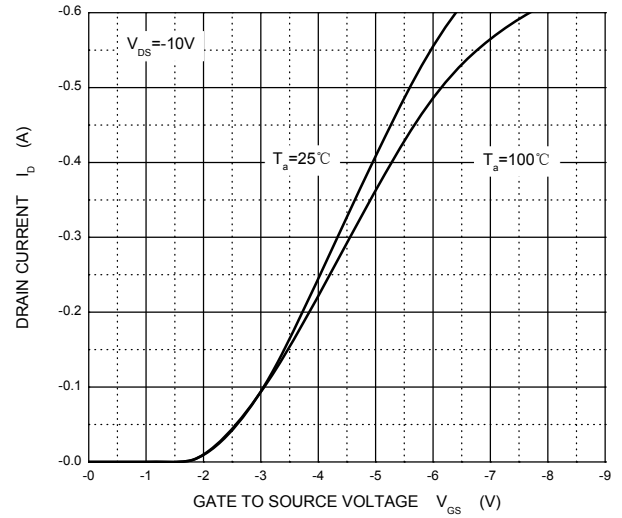

$R_{DS(ON)}$ — I_D

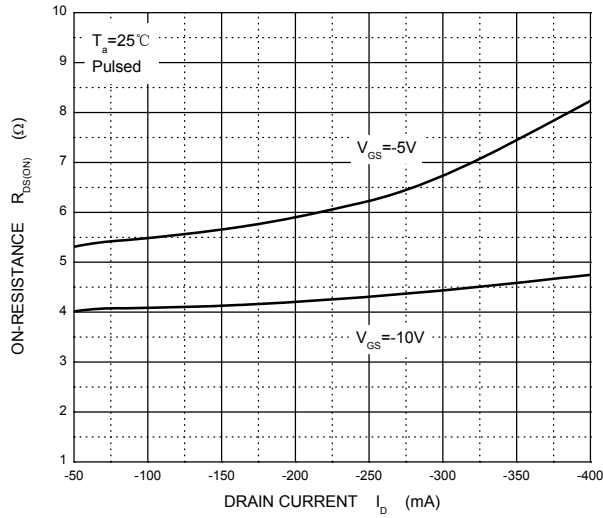

$R_{DS(ON)}$ — V_{GS}

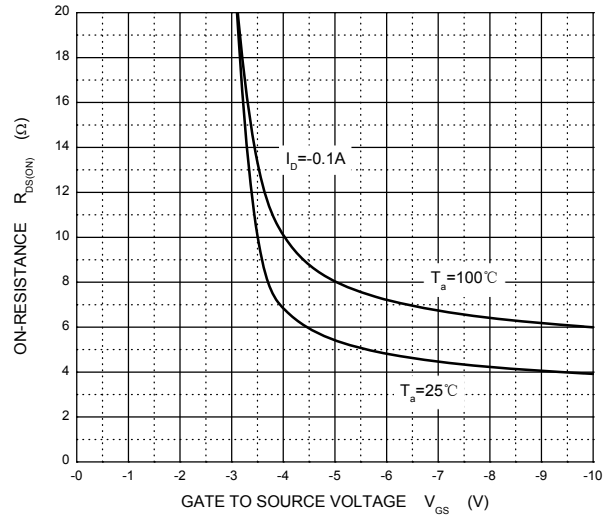

I_S — V_{SD}

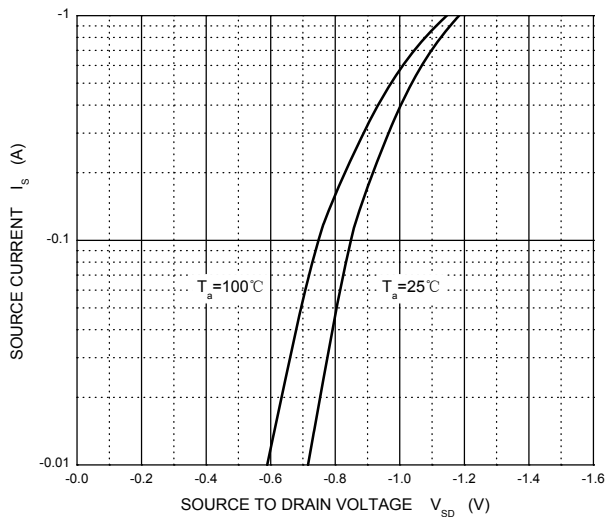

Threshold Voltage

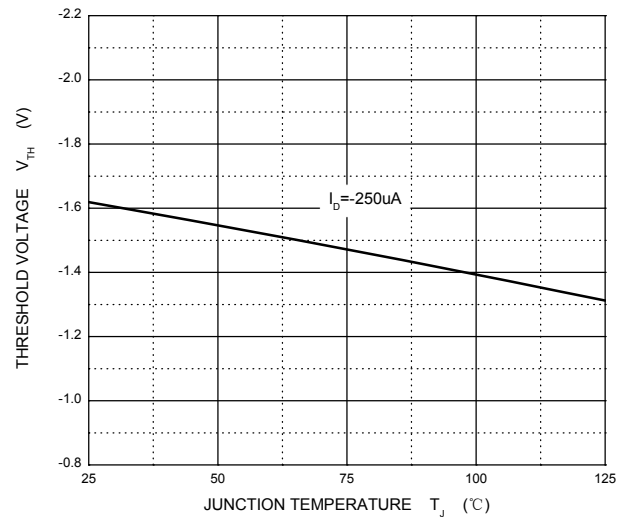

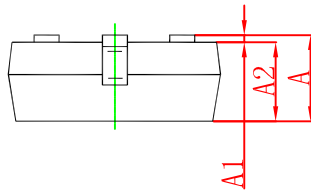
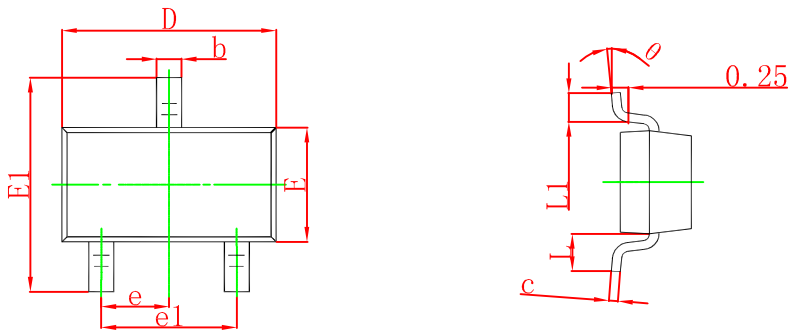

Symbol	Dimensions In Millimeters		Dimensions In Inches	
	Min	Max	Min	Max
A	0.900	1.150	0.035	0.045
A1	0.000	0.100	0.000	0.004
A2	0.900	1.050	0.035	0.041
b	0.300	0.500	0.012	0.020
c	0.080	0.150	0.003	0.006
D	2.800	3.000	0.110	0.118
E	1.200	1.400	0.047	0.055
E1	2.250	2.550	0.089	0.100
e	0.950 TYP		0.037 TYP	
e1	1.800	2.000	0.071	0.079
L	0.550 REF		0.022 REF	
L1	0.300	0.500	0.012	0.020
θ	0°	8°	0°	8°

SOT-23 Suggested Pad Layout

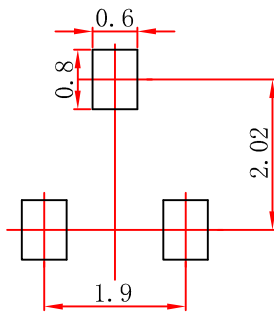

Note:
 1. Controlling dimension: in millimeters.
 2. General tolerance: ± 0.05mm.
 3. The pad layout is for reference purposes only.

SOT-23 Tape and reel

SOT-23 Embossed Carrier Tape

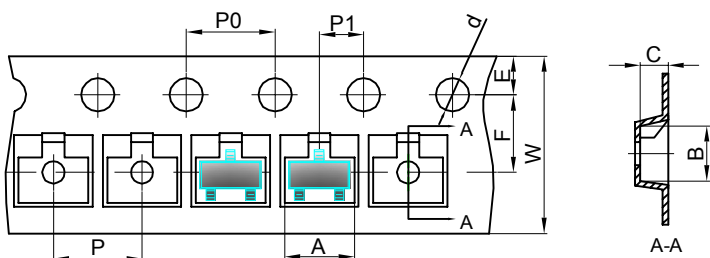

Packaging Description:

SOT-23 parts are shipped in tape. The carrier tape is made from a dissipative (carbon filled) polycarbonate resin. The cover tape is a multilayer film (Heat Activated Adhesive in nature) primarily composed of polyester film, adhesive layer, sealant, and anti-static sprayed agent. These reeled parts in standard option are shipped with 3,000 units per 7" or 17.8cm diameter reel. The reels are clear in color and is made of polystyrene plastic (anti-static coated).

Dimensions are in millimeter										
Pkg type	A	B	C	d	E	F	P0	P	P1	W
SOT-23	3.15	2.77	1.22	Ø1.50	1.75	3.50	4.00	4.00	2.00	8.00

SOT-23 Tape Leader and Trailer

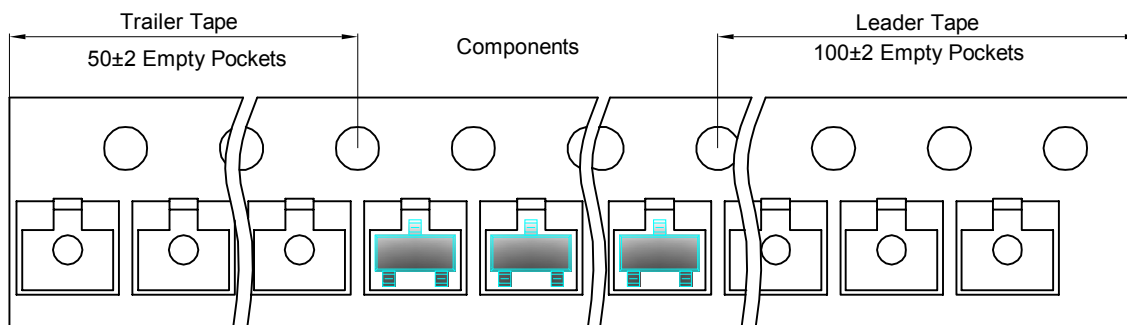

SOT-23 Reel

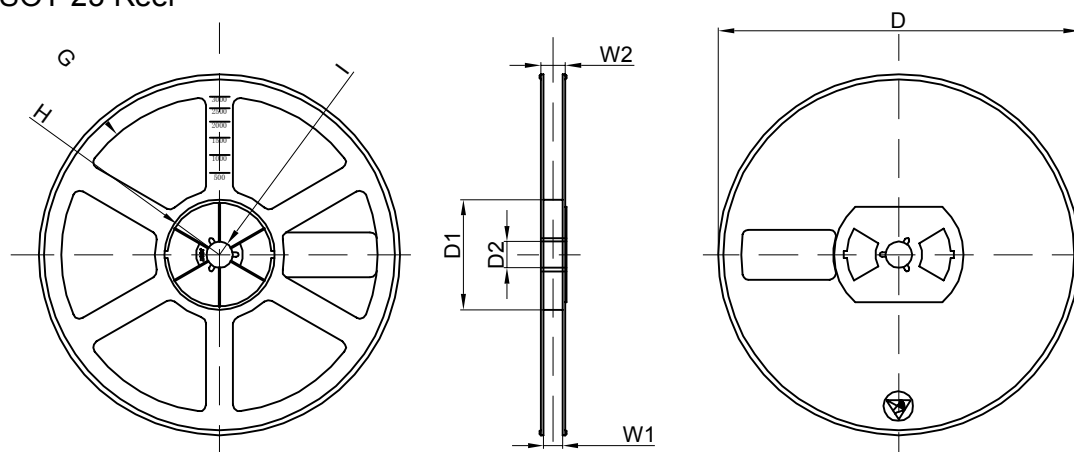

Dimensions are in millimeter								
Reel Option	D	D1	D2	G	H	I	W1	W2
7" Dia	Ø178.00	54.40	13.00	R78.00	R25.60	R6.50	9.50	12.30

REEL	Reel Size	Box	Box Size(mm)	Carton	Carton Size(mm)	G.W.(kg)
3000 pcs	7 inch	30,000 pcs	203×203×195	120,000 pcs	438×438×220	