

## General Description

The AO4805 uses advanced trench technology to provide excellent  $R_{DS(ON)}$ , and ultra-low low gate charge with a 25V gate rating. This device is suitable for use as a load switch or in PWM applications.

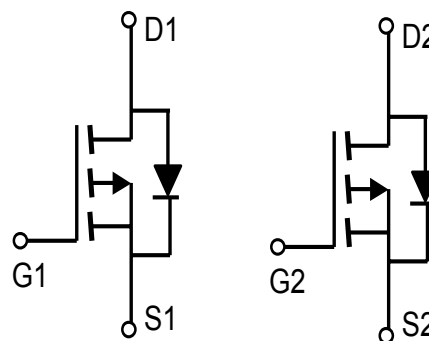

## Features

$$V_{DS} (V) = -30V$$

$$I_D = -9A$$

$$R_{DS(ON)} < 15m\Omega (V_{GS} = 10V)$$

$$R_{DS(ON)} < 19m\Omega (V_{GS} = 4.5V)$$

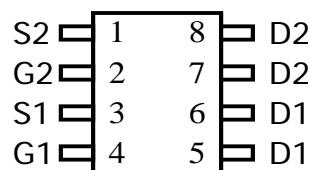

## Absolute Maximum Ratings $T_A=25^\circ\text{C}$ unless otherwise noted

Parameter	Symbol	Maximum	Units
Drain-Source Voltage	$V_{DS}$	-30	V
Gate-Source Voltage	$V_{GS}$	$\pm 20$	V
Continuous Drain Current <sup>A</sup>	$I_D$	$T_A=25^\circ\text{C}$	-8
		$T_A=70^\circ\text{C}$	-6.9
Pulsed Drain Current <sup>B</sup>	$I_{DM}$	-40	A
Power Dissipation <sup>A</sup>	$P_D$	$T_A=25^\circ\text{C}$	2
		$T_A=70^\circ\text{C}$	1.44
Junction and Storage Temperature Range	$T_J, T_{STG}$	-55 to 150	$^\circ\text{C}$

## Thermal Characteristics

Parameter	Symbol	Typ	Max	Units
Maximum Junction-to-Ambient <sup>A</sup>	$R_{\theta JA}$	$t \leq 10s$	50	$^\circ\text{C}/\text{W}$
Maximum Junction-to-Ambient <sup>A</sup>		Steady-State	73	110
Maximum Junction-to-Lead <sup>C</sup>	$R_{\theta JL}$	31	40	$^\circ\text{C}/\text{W}$

Electrical Characteristics ( $T_J=25^\circ\text{C}$  unless otherwise noted)

Symbol	Parameter	Conditions	Min	Typ	Max	Units
$BV_{DSS}$	Drain-Source Breakdown Voltage	$I_D=-250\mu\text{A}$ , $V_{GS}=0\text{V}$	-30			V
$I_{DSS}$	Zero Gate Voltage Drain Current	$V_{DS}=-24\text{V}$ , $V_{GS}=0\text{V}$			-1	$\mu\text{A}$
		$T_J=55^\circ\text{C}$			-5	
$I_{GSS}$	Gate-Body leakage current	$V_{DS}=0\text{V}$ , $V_{GS}=\pm 20\text{V}$			$\pm 100$	nA
$V_{GS(th)}$	Gate Threshold Voltage	$V_{DS}=V_{GS}$ , $I_D=-250\mu\text{A}$	-1	-1.5	-2.5	V
$I_{D(ON)}$	On state drain current	$V_{GS}=-10\text{V}$ , $V_{DS}=-5\text{V}$	40			A
		$V_{GS}=-10\text{V}$ , $I_D=-8\text{A}$		12	15	$\text{m}\Omega$
$R_{DS(ON)}$	Static Drain-Source On-Resistance	$V_{GS}=-4.5\text{V}$ , $I_D=-5\text{A}$		16	19	$\text{m}\Omega$
$g_{FS}$	Forward Transconductance	$V_{DS}=-5\text{V}$ , $I_D=-8\text{A}$	16	21		S
$V_{SD}$	Diode Forward Voltage	$I_S=-1\text{A}$ , $V_{GS}=0\text{V}$		-0.75	-1	V
$I_S$	Maximum Body-Diode Continuous Current				-2.6	A
$C_{iss}$	Input Capacitance			2076		pF
$C_{oss}$	Output Capacitance	$V_{GS}=0\text{V}$ , $V_{DS}=-15\text{V}$ , $f=1\text{MHz}$		503		pF
$C_{rss}$	Reverse Transfer Capacitance			302		pF
$R_g$	Gate resistance	$V_{GS}=0\text{V}$ , $V_{DS}=0\text{V}$ , $f=1\text{MHz}$		2		$\Omega$
$Q_g$	Total Gate Charge			39		nC
$Q_{gs}$	Gate Source Charge	$V_{GS}=-10\text{V}$ , $V_{DS}=-15\text{V}$ , $I_D=-8\text{A}$		8		nC
$Q_{gd}$	Gate Drain Charge			11.4		nC
$t_{D(on)}$	Turn-On Delay Time			12.7		ns
$t_r$	Turn-On Rise Time	$V_{GS}=-10\text{V}$ , $V_{DS}=-15\text{V}$ , $R_L=1.8\Omega$ , $R_{GEN}=3\Omega$		7		ns
$t_{D(off)}$	Turn-Off Delay Time			25.2		ns
$t_f$	Turn-Off Fall Time			12		ns
$t_{rr}$	Body Diode Reverse Recovery Time	$I_F=-8\text{A}$ , $dI/dt=100\text{A}/\mu\text{s}$		32		ns
$Q_{rr}$	Body Diode Reverse Recovery Charge	$I_F=-8\text{A}$ , $dI/dt=100\text{A}/\mu\text{s}$		26		nC

A: The value of  $R_{\theta JA}$  is measured with the device mounted on 1in<sup>2</sup> FR-4 board with 2oz. Copper, in a still air environment with  $T_A=25^\circ\text{C}$ . The value in any a given application depends on the user's specific board design. The current rating is based on the  $t \leq 10\text{s}$  thermal resistance rating.

B: Repetitive rating, pulse width limited by junction temperature.

C: The  $R_{\theta JA}$  is the sum of the thermal impedance from junction to lead  $R_{\theta JL}$  and lead to ambient.

D: The static characteristics in Figures 1 to 6, 12, 14 are obtained using 80 $\mu\text{s}$  pulses, duty cycle 0.5% max.

E: These tests are performed with the device mounted on 1 in<sup>2</sup> FR-4 board with 2oz. Copper, in a still air environment with  $T_A=25^\circ\text{C}$ . The SOA curve provides a single pulse rating.

TYPICAL ELECTRICAL AND THERMAL CHARACTERISTICS

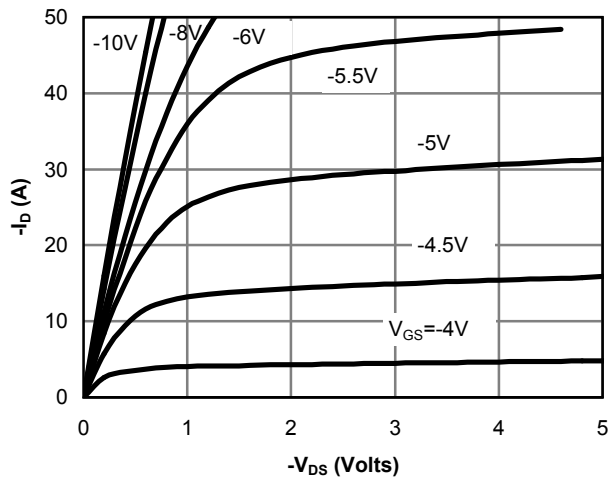

Fig 1: On-Region Characteristics

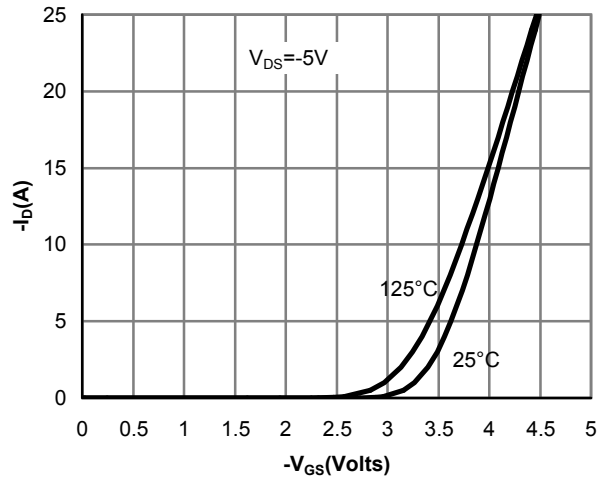

Figure 2: Transfer Characteristics

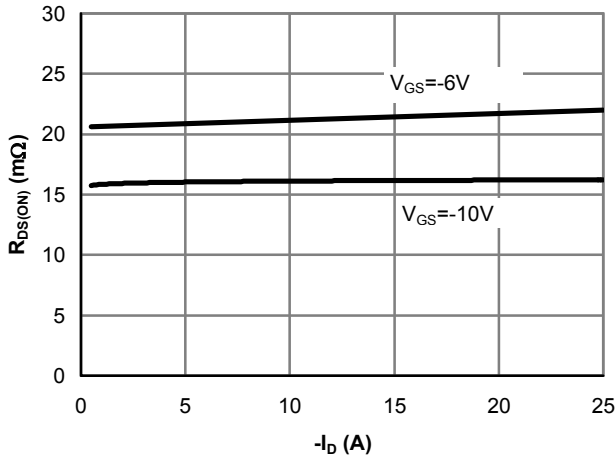

Figure 3: On-Resistance vs. Drain Current and Gate Voltage

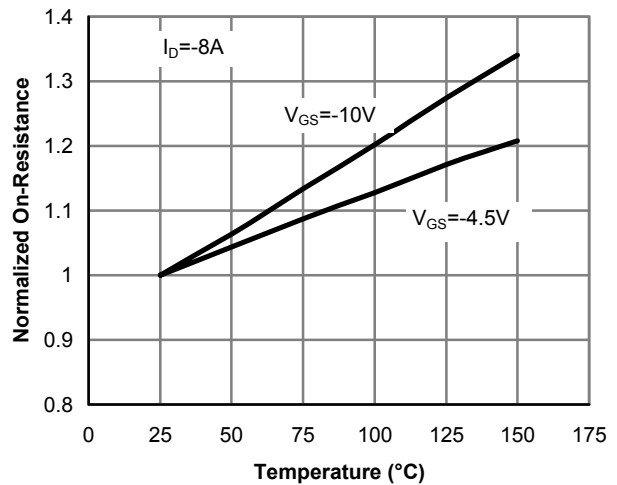

Figure 4: On-Resistance vs. Junction Temperature

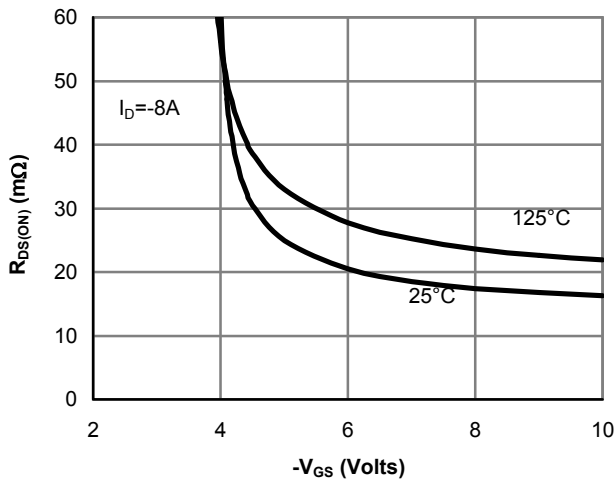

Figure 5: On-Resistance vs. Gate-Source Voltage

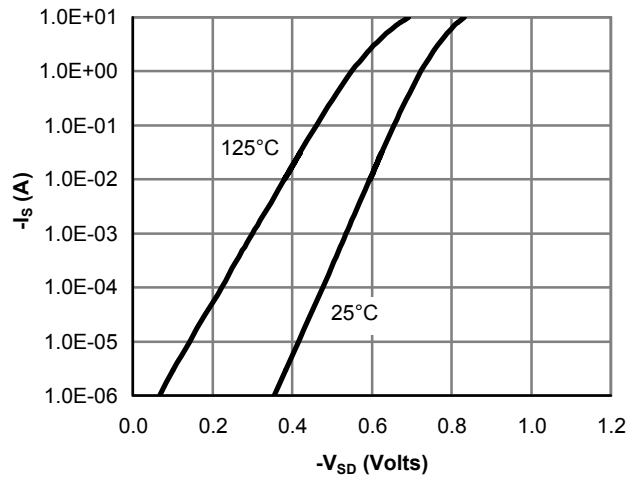

Figure 6: Body-Diode Characteristics

TYPICAL ELECTRICAL AND THERMAL CHARACTERISTICS

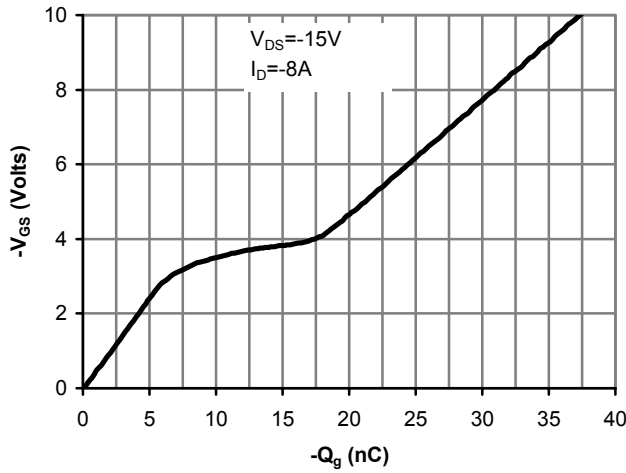

Figure 7: Gate-Charge Characteristics

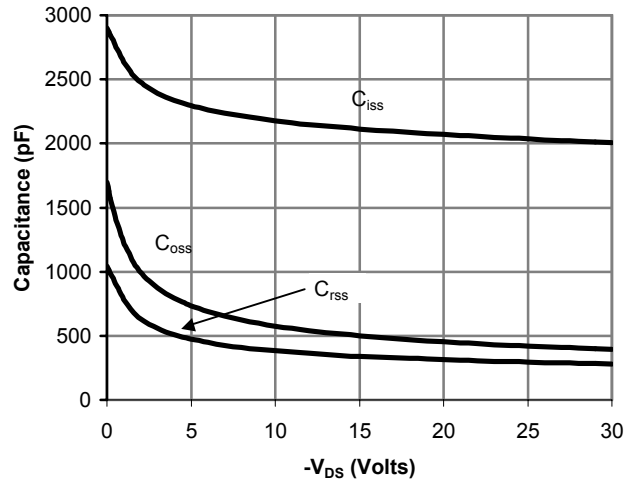

Figure 8: Capacitance Characteristics

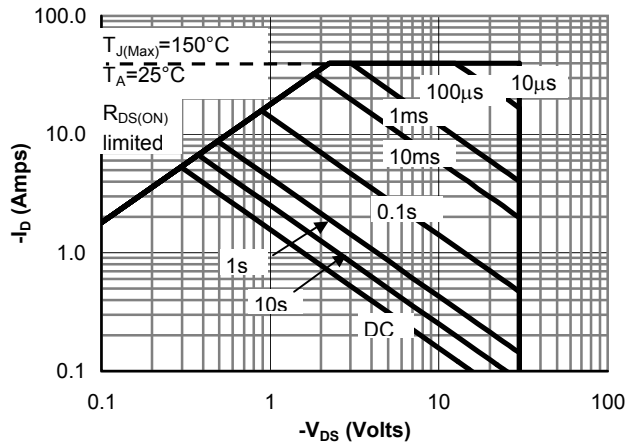

Figure 9: Maximum Forward Biased Safe Operating Area (Note E)

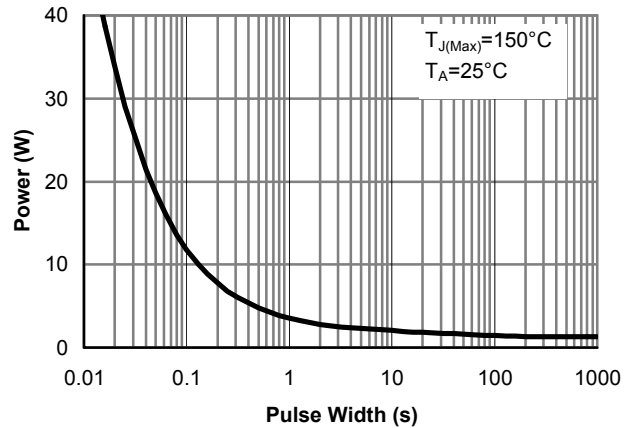

Figure 10: Single Pulse Power Rating Junction-to-Ambient (Note E)

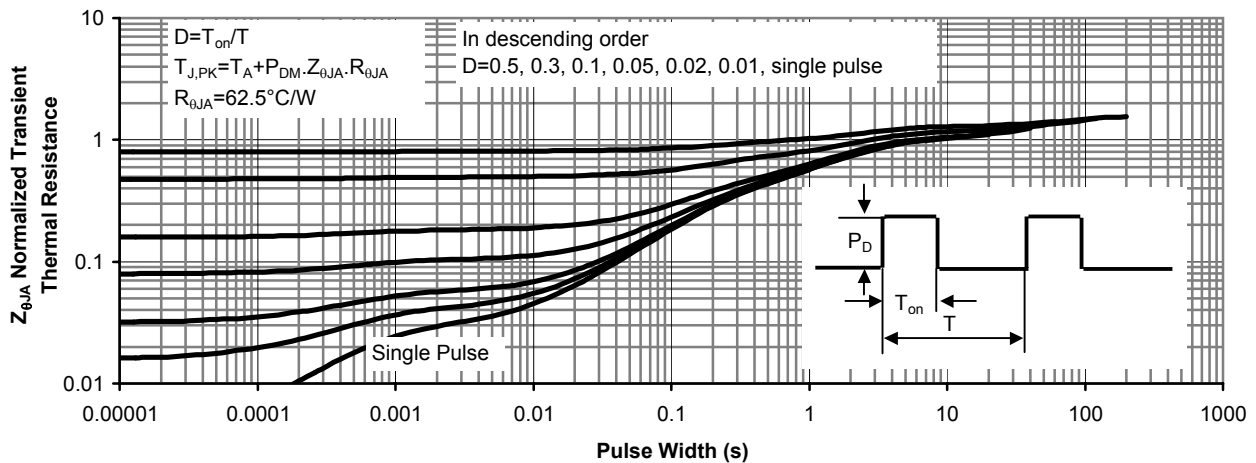
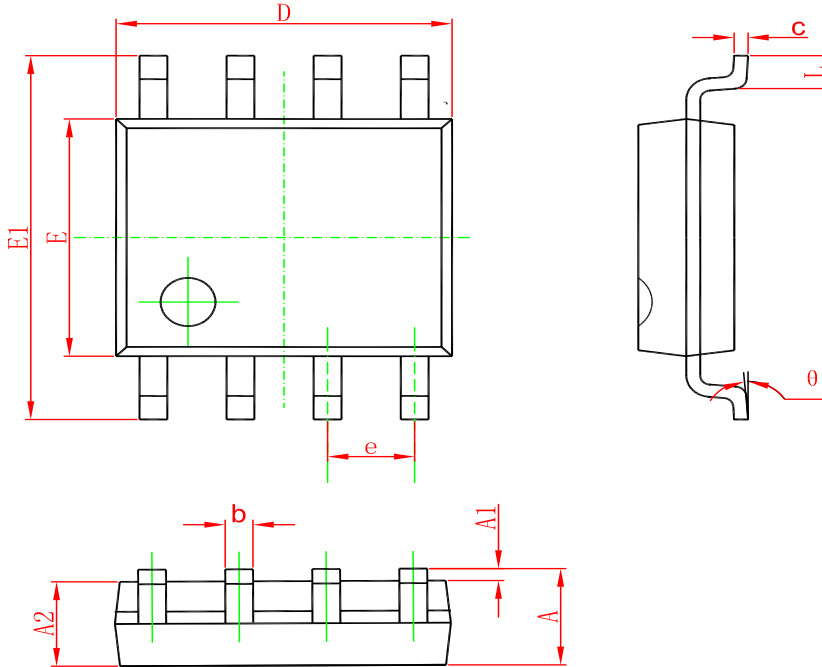

Figure 11: Normalized Maximum Transient Thermal Impedance

PACKAGE OUTLINE DIMENSIONS

SOP-8



Symbol	Dimensions In Millimeters		Dimensions In Inches	
	Min	Max	Min	Max
A	<del>1.350</del>	1.750	0.053	0.069
A1	0.100	0.250	0.004	0.010
A2	1.350	1.550	0.053	0.061
b	0.330	0.510	0.013	0.020
<del>c</del>	0.170	0.250	0.006	0.010
<del>D</del>	<del>4.700</del>	5.100	0.185	0.200
E	3.800	4.000	0.150	0.157
E1	5.800	6.200	0.228	0.244
e	1.270(BSC)		0.050(BSC)	
L	0.400	1.270	0.016	0.050
θ	0°	8°	0°	8°

## Marking

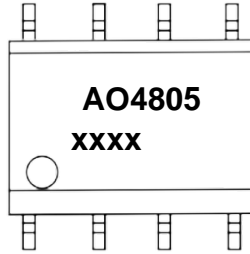

("xxxx"代表年份周期)

## Ordering information

Order code	Package	Baseqty	Deliverymode
AO4805	SOP-8	3000	Tape and reel