

30V N+P-Channel Enhancement Mode MOSFET

Description

AO4406 uses advanced trench technology to provide excellent $R_{DS(ON)}$, low gate charge and operation with gate voltages as low as 4.5V. This device is suitable for use as a Battery protection or in other Switching application.

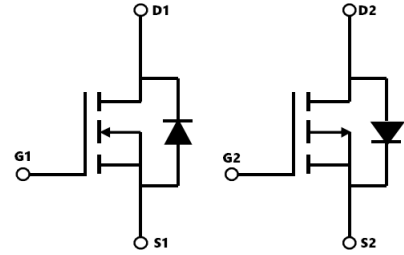

General Features

$$V_{DS} = 30V \quad I_D = 6 \text{ A}$$

$$R_{DS(ON)} < 28m\Omega @ V_{GS}=10V \quad R_{DS(ON)} < 42m\Omega @ V_{GS}=4.5V$$

$$V_{DS} = -30V \quad I_D = -7.6 \text{ A}$$

$$R_{DS(ON)} < 32m\Omega @ V_{GS}=10V \quad R_{DS(ON)} < 40m\Omega @ V_{GS}=4.5V$$

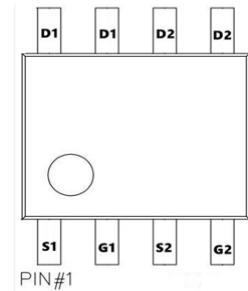
Absolute Maximum Ratings ($T_C=25^\circ\text{C}$ unless otherwise noted)

Symbol	Parameter	Rating		Units
		N-Ch	P-Ch	
VDS	Drain-Source Voltage	30	-30	V
VGS	Gate-Source Voltage	± 20	± 20	V
$I_D@T_C=25^\circ\text{C}$	Continuous Drain Current, $V_{GS} @ 10V^1$	6	-7.6	A
$I_D@T_C=100^\circ\text{C}$	Continuous Drain Current, $V_{GS} @ 10V^1$	4.5	-5.9	A
IDM	Pulsed Drain Current ²	20	-15	A
EAS	Single Pulse Avalanche Energy ³	22	45	mJ
IAS	Avalanche Current	21	-30	A
$P_D@T_C=25^\circ\text{C}$	Total Power Dissipation ⁴	2.0	2.0	W
TSTG	Storage Temperature Range	-55 to 150	-55 to 150	$^\circ\text{C}$
T_J	Operating Junction Temperature Range	-55 to 150	-55 to 150	$^\circ\text{C}$
$R_{\theta JA}$	Thermal Resistance Junction-Ambient ¹	---	62	$^\circ\text{C/W}$
$R_{\theta JC}$	Thermal Resistance Junction-Case ¹	---	5	$^\circ\text{C/W}$

30V N+P-Channel Enhancement Mode MOSFET

N-Channel Electrical Characteristics ($T_J=25^\circ\text{C}$, unless otherwise noted)

Symbol	Parameter	Conditions	Min.	Typ.	Max.	Unit
BV_{DSS}	Drain-Source Breakdown Voltage	$V_{GS}=0V, I_D=250\mu A$	30	---	---	V
$\frac{\partial BV_{DSS}}{\partial T_J}$	BVDSS Temperature Coefficient	Reference to 25°C , $I_D=1\text{mA}$	---	0.023	---	$V/^\circ\text{C}$
$R_{DS(ON)}$	Static Drain-Source On-Resistance ²	$V_{GS}=10V, I_D=10A$	---	19	28	m Ω
		$V_{GS}=4.5V, I_D=5A$	---	28	42	
$V_{GS(th)}$	Gate Threshold Voltage		1.0	1.7	2.5	V
$\frac{\partial V_{GS(th)}}{\partial T_J}$	$V_{GS(th)}$ Temperature Coefficient	$V_{GS}=V_{DS}, I_D=250\mu A$	---	-5.2	---	mV/ $^\circ\text{C}$
I_{DSS}	Drain-Source Leakage Current	$V_{DS}=24V, V_{GS}=0V, T_J=25^\circ\text{C}$	---	---	1	uA
		$V_{DS}=24V, V_{GS}=0V, T_J=55^\circ\text{C}$	---	---	5	
I_{GSS}	Gate-Source Leakage Current	$V_{GS}=\pm 20V, V_{DS}=0V$	---	---	± 100	nA
g_{fs}	Forward Transconductance	$V_{DS}=5V, I_D=10A$	---	16	---	S
R_g	Gate Resistance	$V_{DS}=0V, V_{GS}=0V, f=1\text{MHz}$	---	2.5	5	Ω
Q_g	Total Gate Charge (4.5V)		---	7.2	---	nC
Q_{gs}	Gate-Source Charge	$V_{DS}=20V, V_{GS}=4.5V, I_D=10A$	---	1.4	---	
Q_{gd}	Gate-Drain Charge		---	2.2	---	
$T_{d(on)}$	Turn-On Delay Time		---	4.1	---	ns
T_r	Rise Time	$V_{DD}=15V, V_{GS}=10V, R_G=3.3\Omega, I_D=5A$	---	9.8	---	
$T_{d(off)}$	Turn-Off Delay Time		---	15.5	---	
T_f	Fall Time		---	6.0	---	
C_{iss}	Input Capacitance		---	572	---	pF
C_{oss}	Output Capacitance	$V_{DS}=15V, V_{GS}=0V, f=1\text{MHz}$	---	81	---	
C_{rss}	Reverse Transfer Capacitance		---	65	---	
I_S	Continuous Source Current ^{1,5}		---	---	10	A
I_{SM}	Pulsed Source Current ^{2,5}	$V_G=V_D=0V$, Force Current	---	---	20	A
V_{SD}	Diode Forward Voltage ²	$V_{GS}=0V, I_S=1A, T_J=25^\circ\text{C}$	---	---	1.2	V

Note :

- 1.The data tested by surface mounted on a 1 inch² FR-4 board with 2OZ copper.
- 2.The data tested by pulsed , pulse width $\leq 300\mu s$, duty cycle $\leq 2\%$
- 3.The EAS data shows Max. rating . The test condition is $V_{DD}=25V, V_{GS}=10V, L=0.1\text{mH}, I_{AS}=21A$
- 4 .The power dissipation is limited by 150°C junction temperature
- 5.The data is theoretically the same as I_D and I_{DM} , in real applications , should be limited by total power dissipation.

30V N+P-Channel Enhancement Mode MOSFET

P-Channel Electrical Characteristics (T_J=25 °C, unless otherwise noted)

Symbol	Parameter	Conditions	Min.	Typ.	Max.	Unit
BV _{DSS}	Drain-Source Breakdown Voltage	V _{GS} =0V, I _D =-250uA	-30	---	---	V
∂BV _{DSS} /∂T _J	BV _{DSS} Temperature Coefficient	Reference to 25°C, I _D =-1mA	---	-0.021	---	V/°C
R _{DS(ON)}	Static Drain-Source On-Resistance ²	V _{GS} =-10V, I _D =-7A	---	24	32	mΩ
		V _{GS} =-4.5V, I _D =-5A	---	32	40	
V _{GS(th)}	Gate Threshold Voltage		-1.0	-1.6	-2.5	V
∂V _{GS(th)}	V _{GS(th)} Temperature Coefficient	V _{GS} =V _{DS} , I _D =-250uA	---	-4.2	---	mV/°C
I _{DSS}	Drain-Source Leakage Current	V _{DS} =-24V, V _{GS} =0V, T _J =25°C	---	---	1	uA
		V _{DS} =-24V, V _{GS} =0V, T _J =55°C	---	---	5	
I _{GSS}	Gate-Source Leakage Current	V _{GS} =±20V, V _{DS} =0V	---	---	±100	nA
g _{fs}	Forward Transconductance	V _{DS} =-5V, I _D =-7A	---	15	---	S
R _g	Gate Resistance	V _{DS} =0V, V _{GS} =0V, f=1MHz		15	30	
Q _g	Total Gate Charge (-4.5V)	V _{DS} =-20V, V _{GS} =-4.5V, I _D =-7A	---	9.8	---	nC
Q _{gs}	Gate-Source Charge		---	2.2	---	
Q _{gd}	Gate-Drain Charge		---	3.4	---	
T _{d(on)}	Turn-On Delay Time	V _{DD} =-15V, V _{GS} =-10V, R _G =3.3Ω, I _D =-5A	---	16.4	---	ns
T _r	Rise Time		---	20.2	---	
T _{d(off)}	Turn-Off Delay Time		---	55	---	
T _f	Fall Time		---	10	---	
C _{iss}	Input Capacitance	V _{DS} =-15V, V _{GS} =0V, f=1MHz	---	930	---	pF
C _{oss}	Output Capacitance		---	148	---	
C _{rss}	Reverse Transfer Capacitance		---	115	---	
I _S	Continuous Source Current ^{1,5}	V _G =V _D =0V, Force Current	---	---	-7.6	A
I _{SM}	Pulsed Source Current ^{2,5}		---	---	-15	A
V _{SD}	Diode Forward Voltage ²	V _{GS} =0V, I _S =-1A, T _J =25°C	---	---	-1.2	V

Note :

1.The data tested by surface mounted on a 1 inch² FR-4 board with 20Zcopper.

2.The data tested by pulsed, pulse width ≤ 300us, duty cycle ≤ 2%

3.The EAS data sh.The power dissipation is limited by ows Max. rating

4. The test condition is V150°C junction temperature_{DD}=-25 V,V_{GS}=-10V,L=0.1mH,I_{AS}=-30A

5 .The data is theoretically the same as I_D and I_{DM}, in real applications, should be limited by total power dissipation.

30V N+P-Channel Enhancement Mode MOSFET

N-Channel Typical Characteristics

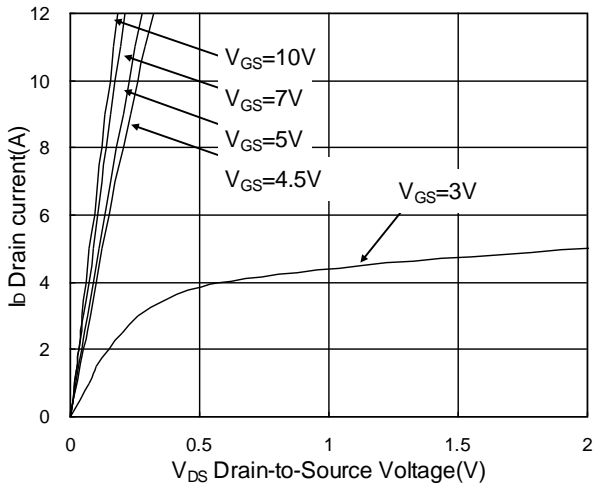

Fig.1 Typical Output Characteristics

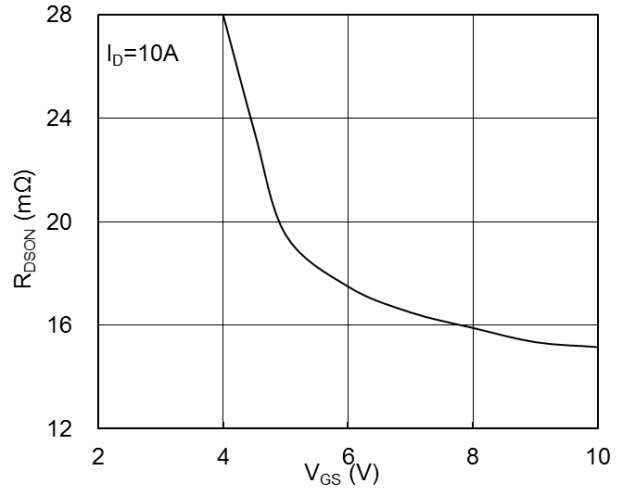

Fig.2 On-Resistance vs Gate-Source Voltage

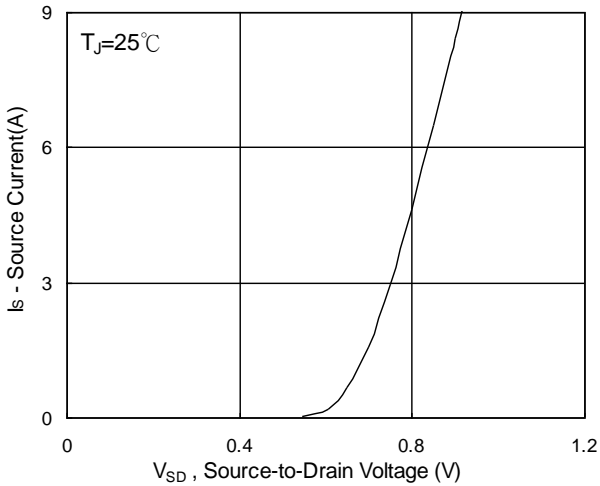

Fig.3 Forward Characteristics of Reverse

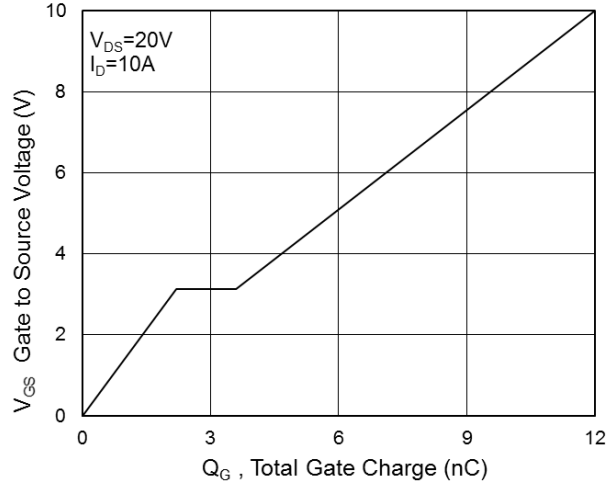

Fig.4 Gate-Charge characteristics

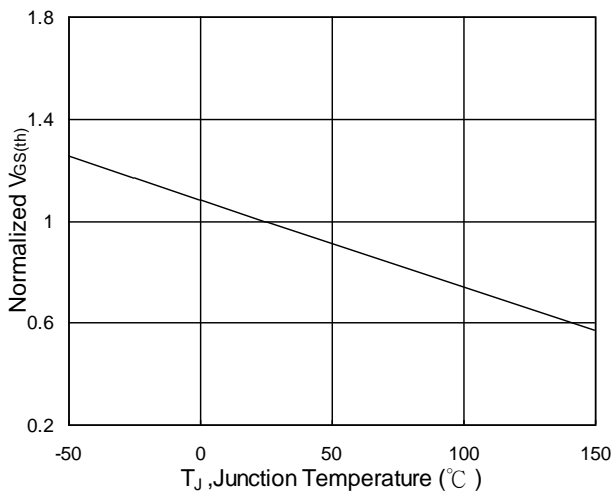

Fig.5 Normalized $V_{GS(th)}$ vs T_J

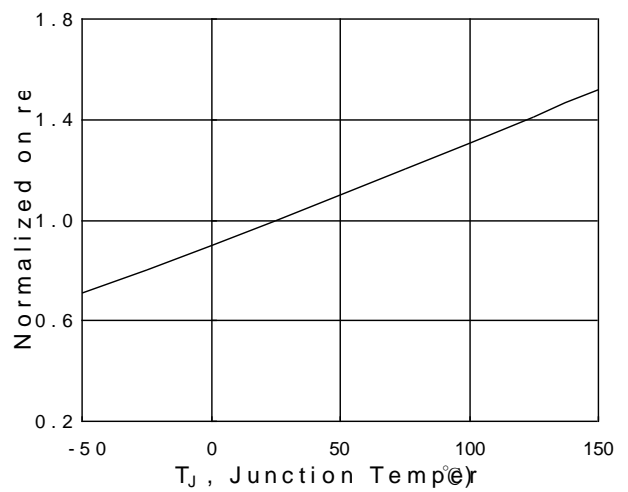

Fig.6 Normalized $R_{DS(on)}$ vs T_J

30V N+P-Channel Enhancement Mode MOSFET

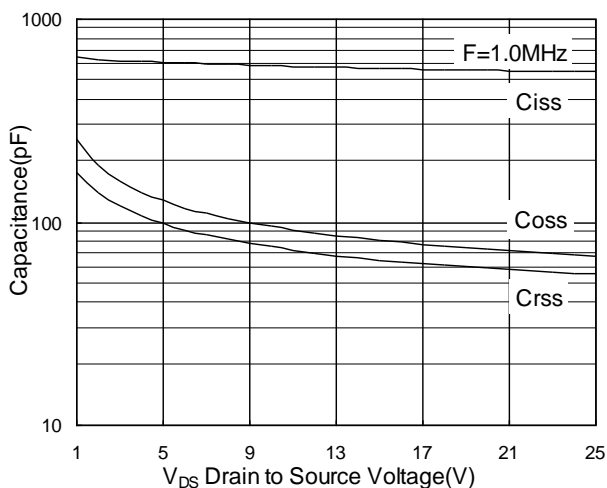

Fig.7 Capacitance

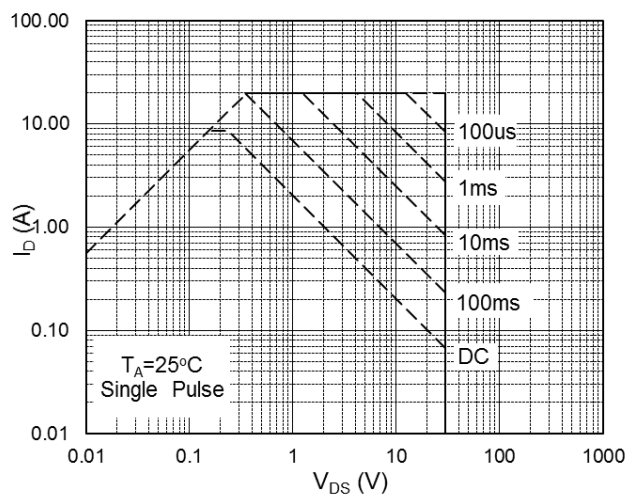

Fig.8 Safe Operating Area

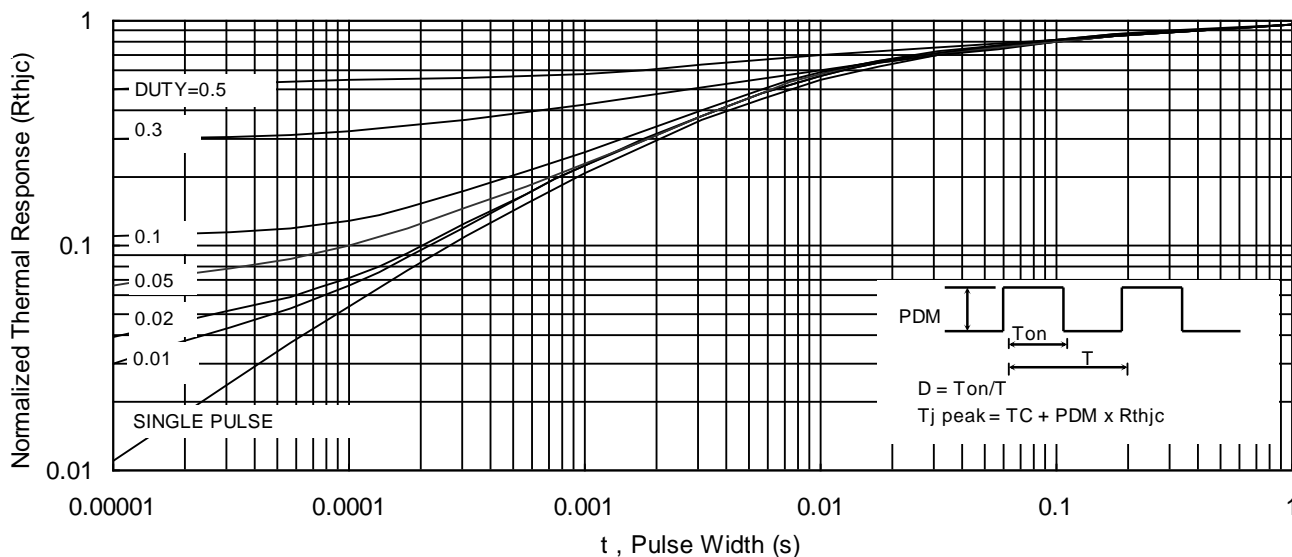

Fig.9 Normalized Maximum Transient Thermal Impedance

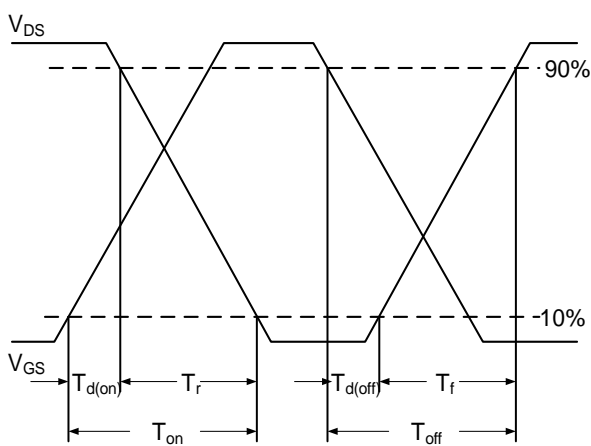

Fig.10 Switching Time Waveform

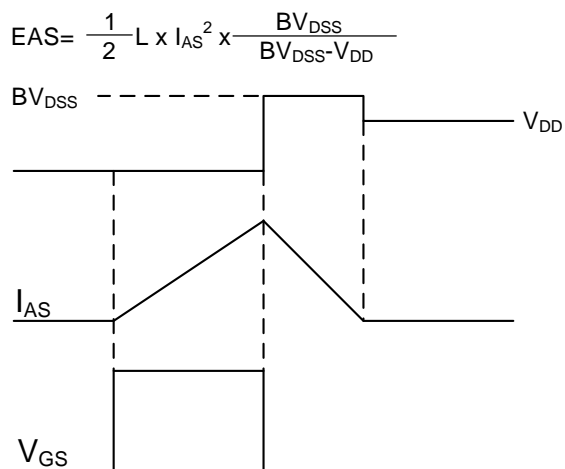

Fig.11 Unclamped Inductive Waveform

P-Channel Typical Characteristics

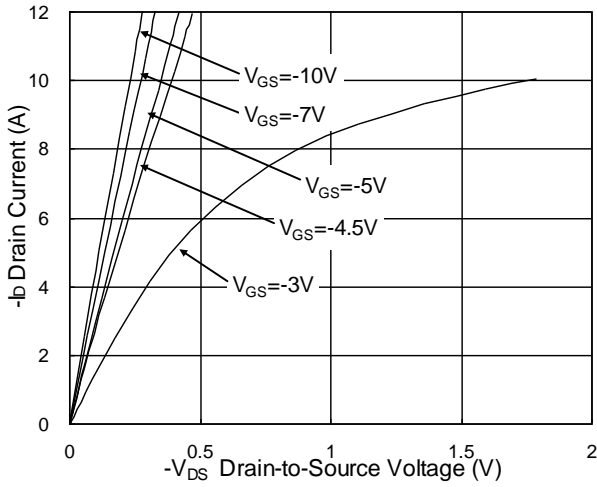

Fig.1 Typical Output Characteristics

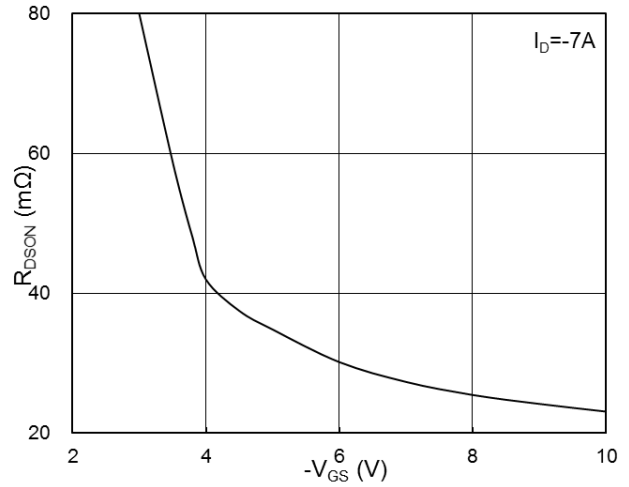

Fig.2 On-Resistance vs Gate-Source Voltage

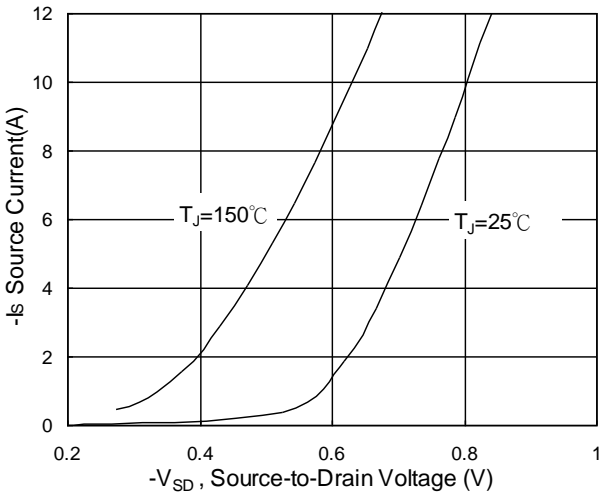

Fig.3 Forward Characteristics of Reverse

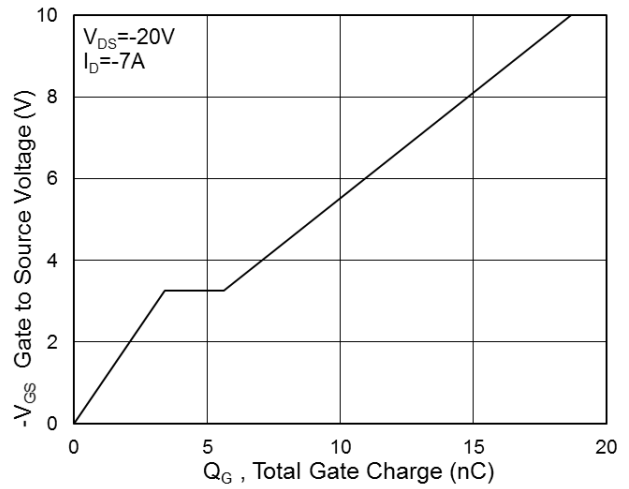

Fig.4 Gate-Charge Characteristics

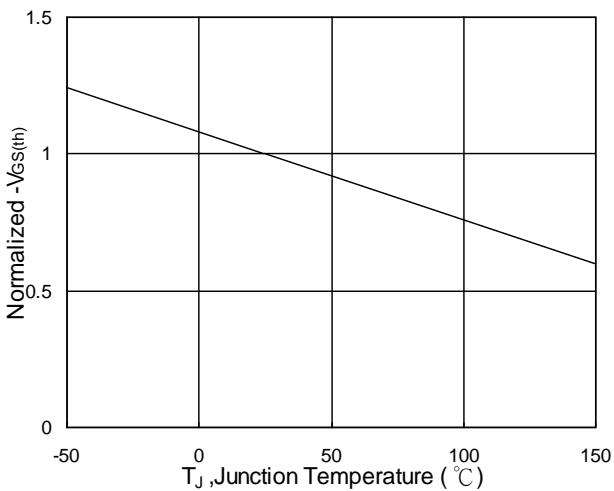

Fig.5 Normalized $V_{GS(th)}$ vs T_J

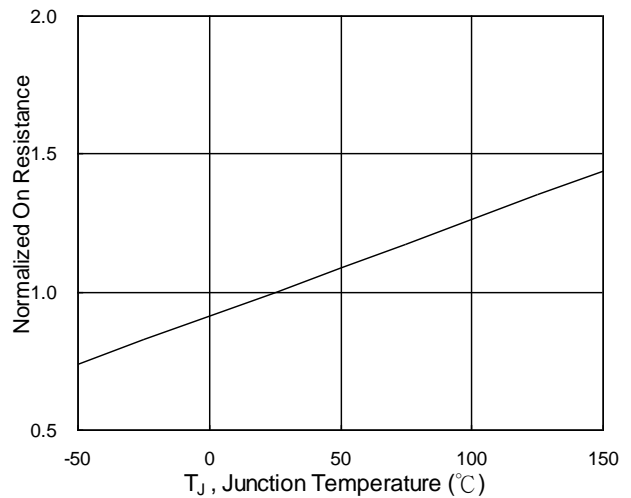

Fig.6 Normalized $R_{DS(on)}$ vs T_J

30V N+P-Channel Enhancement Mode MOSFET

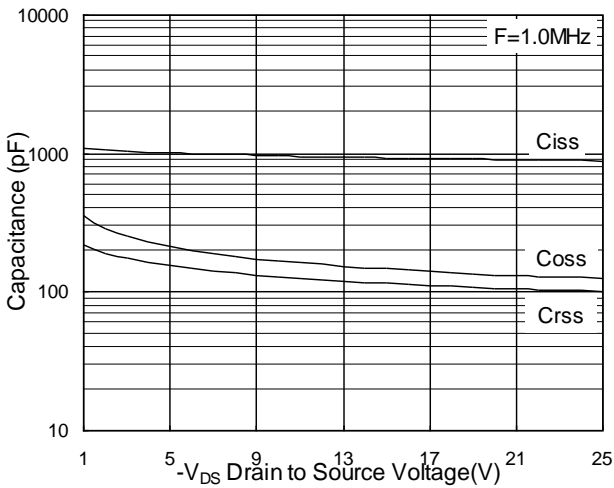

Fig.7 Capacitance

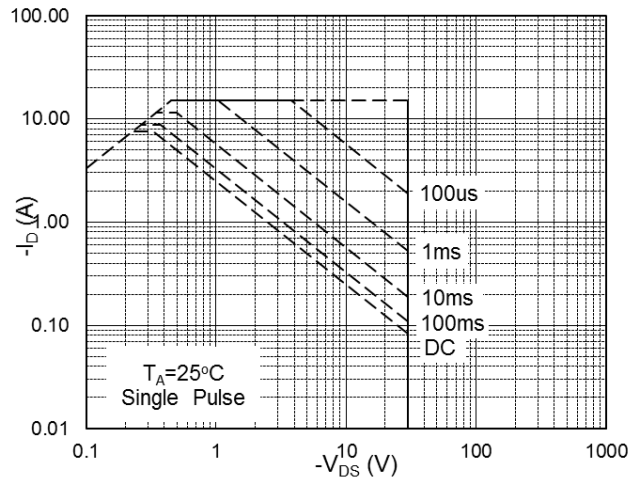

Fig.8 Safe Operating Area

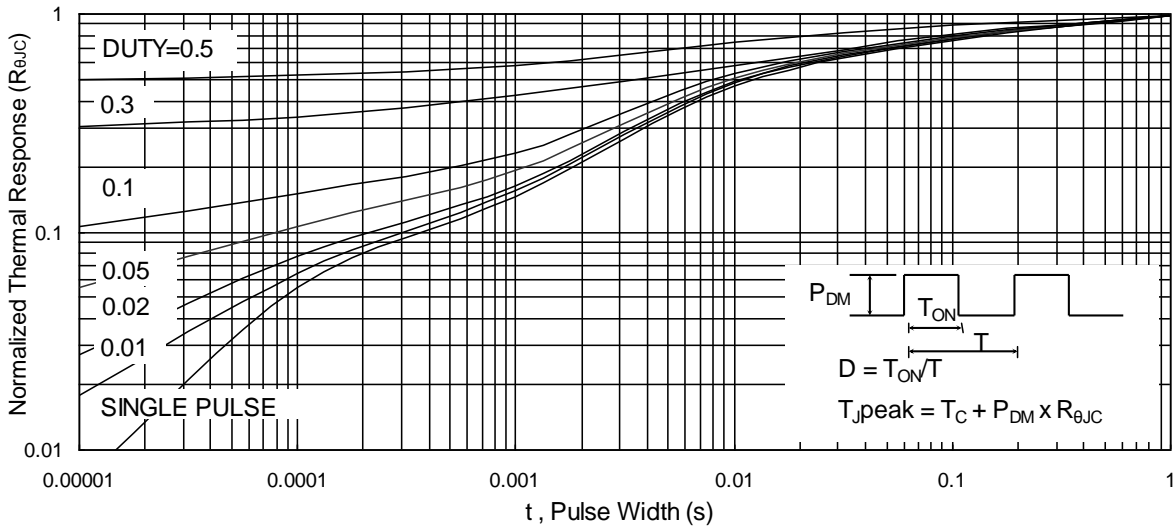

Fig.9 Normalized Maximum Transient Thermal Impedance

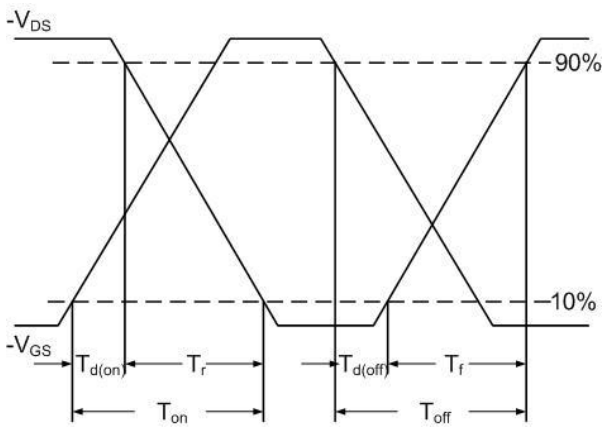

Fig.10 Switching Time Waveform

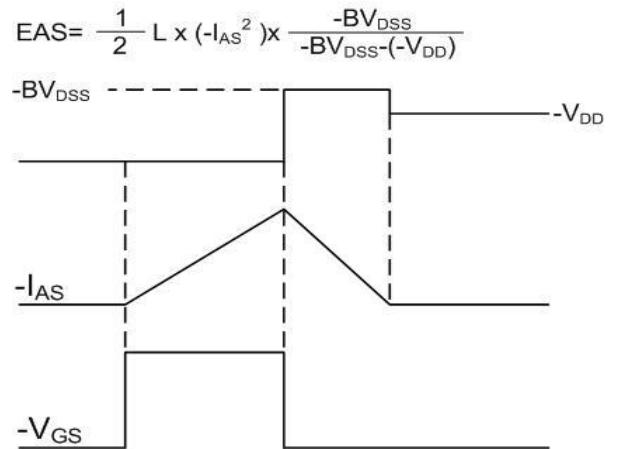
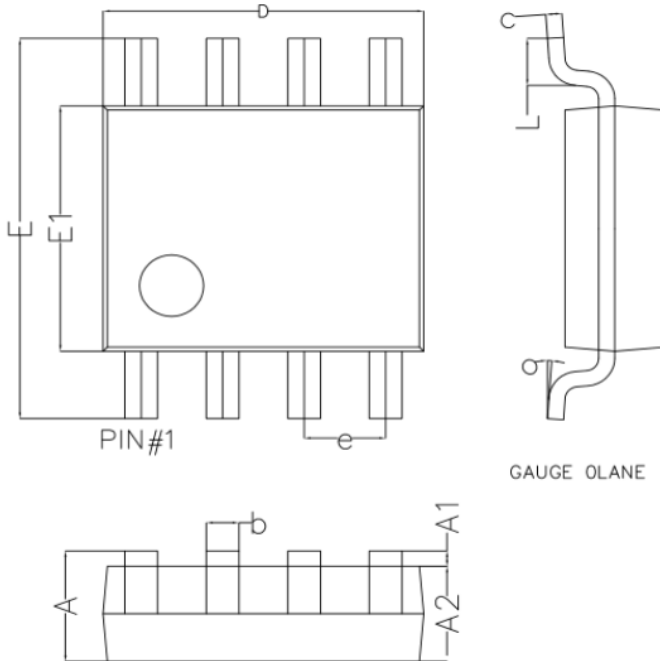

Fig.11 Unclamped Inductive Waveform

Package Mechanical Data-SOP-8



Symbol	Dim in mm		
	Min	Nor	Max
A	1.350	1.550	1.750
A1	0.100	0.175	0.250
A2	1.350	1.450	1.550
b	0.330	0.420	0.510
c	0.170	0.210	0.250
D	4.800	4.900	5.000
e	1.270 (BSC)		
E	5.800	6.000	6.200
E1	3.800	3.900	4.000
L	0.400	0.835	1.2700
o	0°	4°	8°

Marking

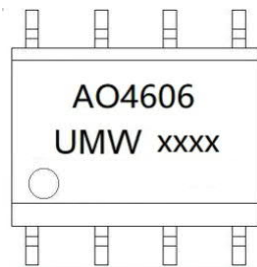

("xxxx"代表年份周期)