

FEATURES

- $V_{DS} (V) = 60V$
- $I_D = 30A$ ($V_{GS} = 10V$)
- $R_{DS(ON)} < 25m\Omega$ ($V_{GS} = 10V$)
- $R_{DS(ON)} < 30m\Omega$ ($V_{GS} = 4.5V$)

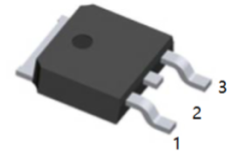

1.G 2.D 3.S
TO-252(DPAK) top view

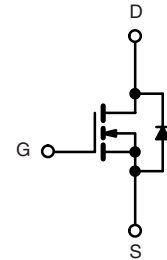

N-Channel MOSFET

ABSOLUTE MAXIMUM RATINGS $T_C = 25\text{ }^\circ\text{C}$, unless otherwise noted

| Parameter | Symbol | Limit | Unit | |
|---|---------------------|-----------------------------------|------------------|----|
| Gate-Source Voltage | V_{GS} | ± 20 | V | |
| Continuous Drain Current ($T_J = 175\text{ }^\circ\text{C}$) ^b | I_D | $T_C = 25\text{ }^\circ\text{C}$ | 35 | |
| | | $T_C = 100\text{ }^\circ\text{C}$ | 28 | |
| Pulsed Drain Current | I_{DM} | 100 | A | |
| Continuous Source Current (Diode Conduction) | I_S | 23 | | |
| Avalanche Current | I_{AS} | 20 | | |
| Single Avalanche Energy (Duty Cycle $\leq 1\%$) | $L = 0.1\text{ mH}$ | E_{AS} | 20 | mJ |
| Maximum Power Dissipation | P_D | $T_C = 25\text{ }^\circ\text{C}$ | 100 | W |
| | | $T_A = 25\text{ }^\circ\text{C}$ | 3 ^a | |
| Operating Junction and Storage Temperature Range | T_J, T_{stg} | - 55 to 175 | $^\circ\text{C}$ | |

THERMAL RESISTANCE RATINGS

| Parameter | Symbol | Typical | Maximum | Unit |
|--|------------|------------------------|---------|--------------------|
| Maximum Junction-to-Ambient ^a | R_{thJA} | $t \leq 10\text{ sec}$ | 18 | 22 |
| | | Steady State | 40 | 50 |
| Maximum Junction-to-Case | R_{thJC} | 3.2 | 4 | $^\circ\text{C/W}$ |

Notes:

a. Surface Mounted on 1" x 1" FR4 board, $t \leq 10\text{ sec}$.

| SPECIFICATIONS $T_J = 25\text{ }^\circ\text{C}$, unless otherwise noted | | | | | | |
|--|---------------|--|-----|------------------|-----------|---------------|
| Parameter | Symbol | Test Conditions | Min | Typ ^a | Max | Unit |
| Static | | | | | | |
| Drain-Source Breakdown Voltage | $V_{(BR)DSS}$ | $V_{GS} = 0\text{ V}, I_D = 250\text{ }\mu\text{A}$ | 60 | | | V |
| Gate Threshold Voltage | $V_{GS(th)}$ | $V_{DS} = V_{GS}, I_D = 250\text{ }\mu\text{A}$ | 1.0 | 2.0 | 3.0 | |
| Gate-Body Leakage | I_{GSS} | $V_{DS} = 0\text{ V}, V_{GS} = \pm 20\text{ V}$ | | | ± 100 | nA |
| Zero Gate Voltage Drain Current | I_{DSS} | $V_{DS} = 60\text{ V}, V_{GS} = 0\text{ V}$ | | | 1 | μA |
| | | $V_{DS} = 60\text{ V}, V_{GS} = 0\text{ V}, T_J = 125\text{ }^\circ\text{C}$ | | | 50 | |
| | | $V_{DS} = 60\text{ V}, V_{GS} = 0\text{ V}, T_J = 175\text{ }^\circ\text{C}$ | | | 250 | |
| On-State Drain Current ^b | $I_{D(on)}$ | $V_{DS} = 5\text{ V}, V_{GS} = 10\text{ V}$ | 50 | | | A |
| Drain-Source On-State Resistance ^b | $r_{DS(on)}$ | $V_{GS} = 10\text{ V}, I_D = 15\text{ A}$ | | 25 | 31 | m Ω |
| | | $V_{GS} = 4.5\text{ V}, I_D = 10\text{ A}$ | | 30 | 45 | |
| Forward Transconductance ^b | g_{fs} | $V_{DS} = 15\text{ V}, I_D = 15\text{ A}$ | | 20 | | S |
| Dynamic^a | | | | | | |
| Input Capacitance | C_{iss} | $V_{GS} = 0\text{ V}, V_{DS} = 25\text{ V}, f = 1\text{ MHz}$ | | 670 | | μF |
| Output Capacitance | C_{oss} | | | 140 | | |
| Reverse Transfer Capacitance | C_{rss} | | | 60 | | |
| Total Gate Charge ^c | Q_g | $V_{DS} = 30\text{ V}, V_{GS} = 10\text{ V}, I_D = 23\text{ A}$ | | 11 | 17 | nC |
| Gate-Source Charge ^c | Q_{gs} | | | 3 | | |
| Gate-Drain Charge ^c | Q_{gd} | | | 3 | | |
| Turn-On Delay Time ^c | $t_{d(on)}$ | $V_{DD} = 30\text{ V}, R_L = 1.3\text{ }\Omega$ $I_D \cong 23\text{ A}, V_{GEN} = 10\text{ V}, R_g = 2.5\text{ }\Omega$ | | 8 | 15 | ns |
| Rise Time ^c | t_r | | | 15 | 25 | |
| Turn-Off Delay Time ^c | $t_{d(off)}$ | | | 30 | 45 | |
| Fall Time ^c | t_f | | | 25 | 40 | |
| | | | | | | |
| Source-Drain Diode Ratings and Characteristics ($T_C = 25\text{ }^\circ\text{C}$) | | | | | | |
| Pulsed Current | I_{SM} | | | | 50 | A |
| Diode Forward Voltage | V_{SD} | $I_F = 15\text{ A}, V_{GS} = 0\text{ V}$ | | 1.0 | 1.5 | V |
| Reverse Recovery Time | t_{rr} | $I_F = 15\text{ A}, di/dt = 100\text{ A}/\mu\text{s}$ | | 30 | 60 | ns |

Notes:

- a. For design aid only; not subject to production testing.
b. Pulse test; pulse width $\leq 300\text{ }\mu\text{s}$, duty cycle $\leq 2\%$.
c. Independent of operating temperature.

TYPICAL CHARACTERISTICS 25 °C unless noted

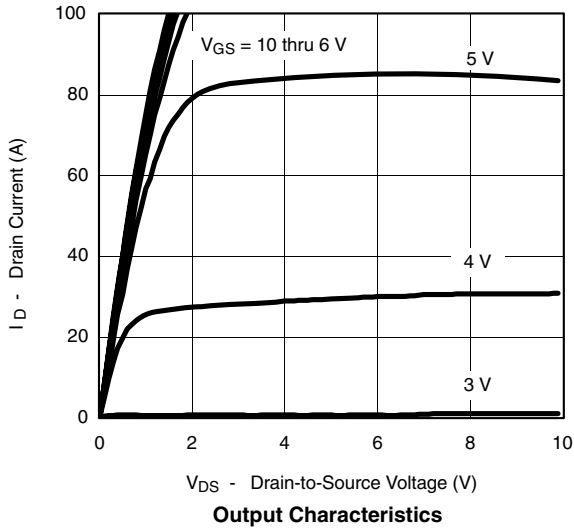

Output Characteristics

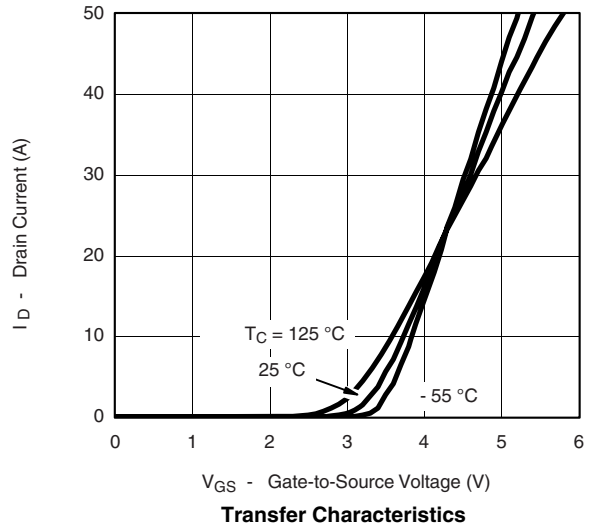

Transfer Characteristics

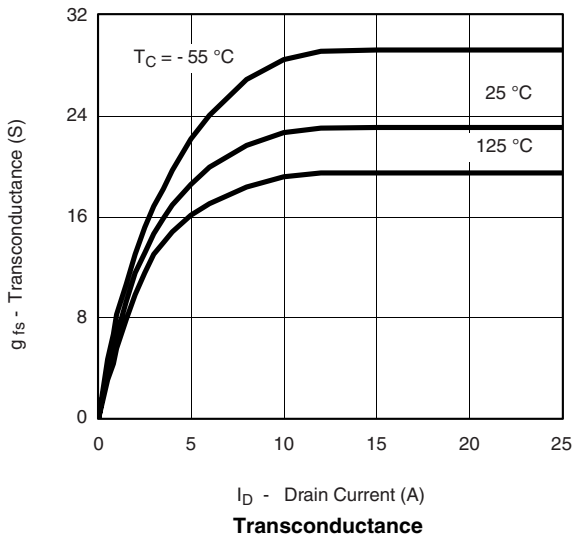

Transconductance

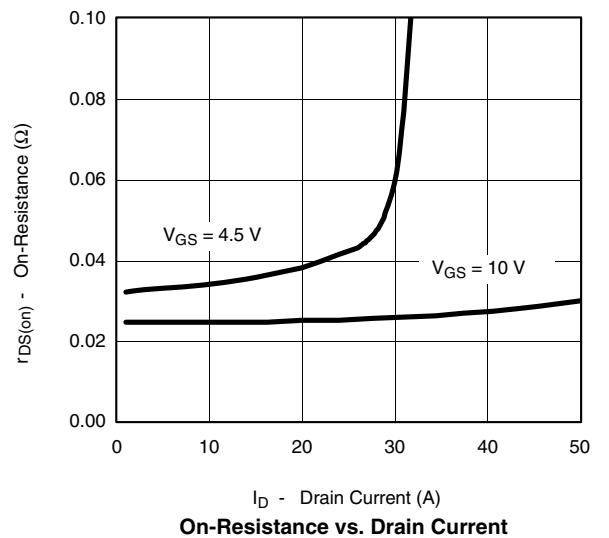

On-Resistance vs. Drain Current

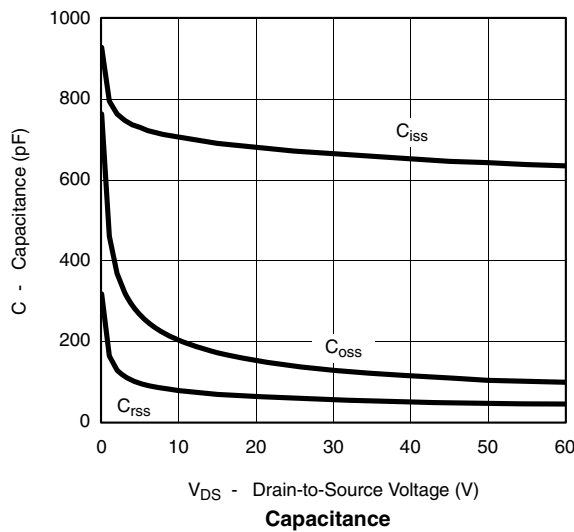

Capacitance

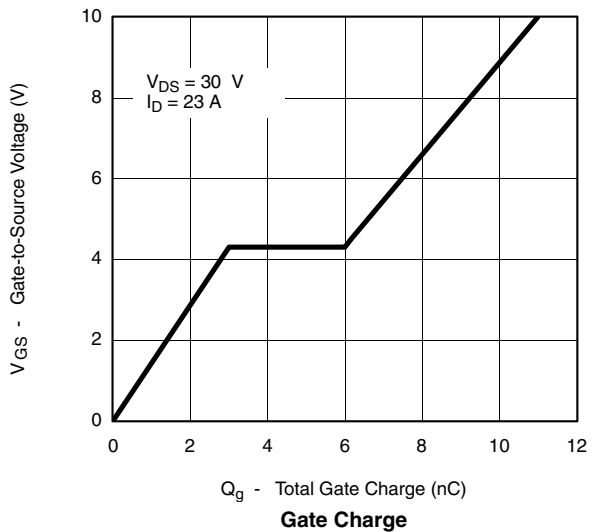

Gate Charge

TYPICAL CHARACTERISTICS 25 °C unless noted

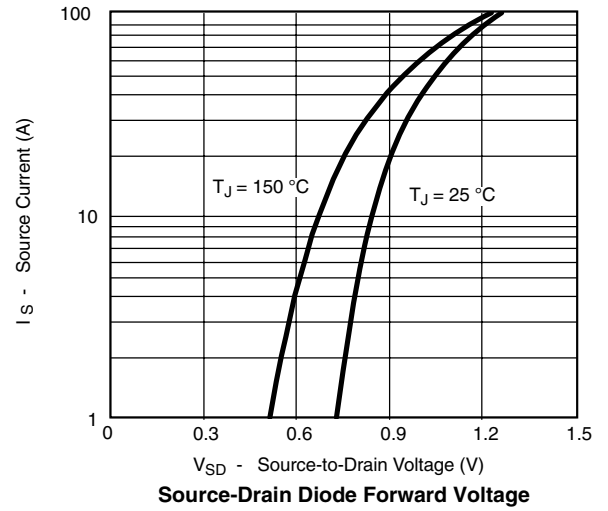
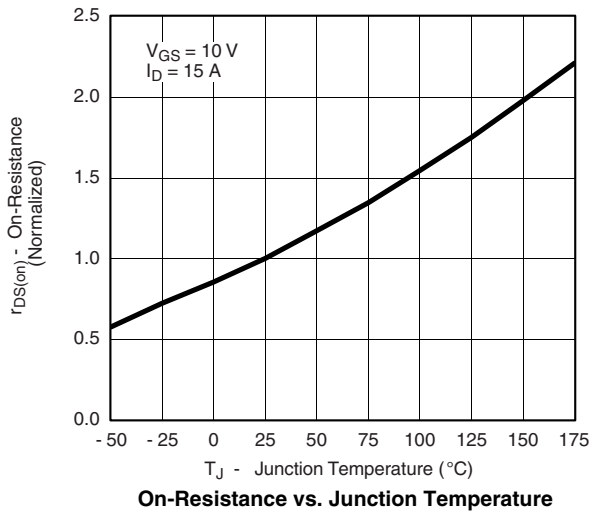

THERMAL RATINGS

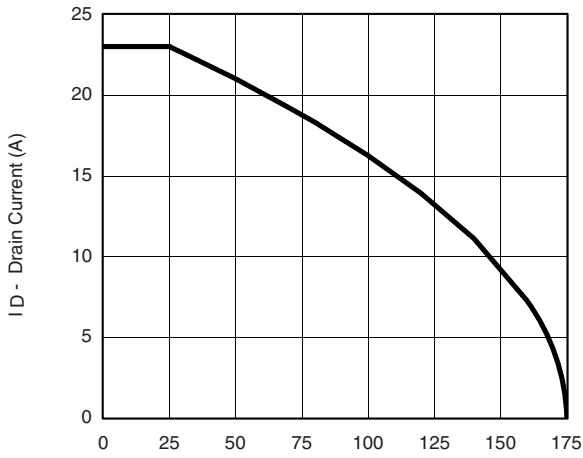

Maximum Drain Current vs. Ambient Temperature

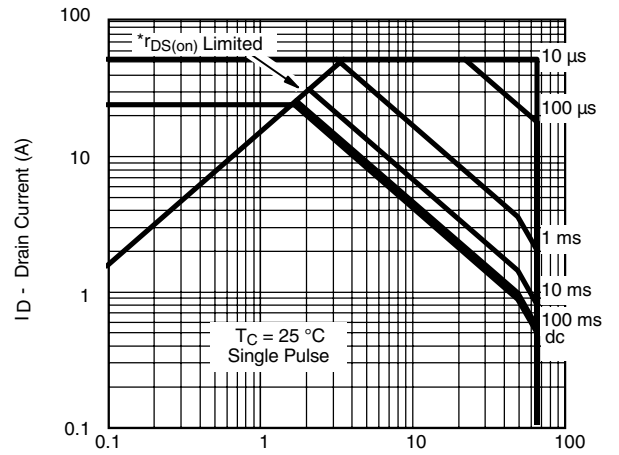

Safe Operating Area
 V_{DS} - Drain-to-Source Voltage (V)
 $V_{GS} >$ minimum V_{GS} at which $r_{DS(on)}$ is specified

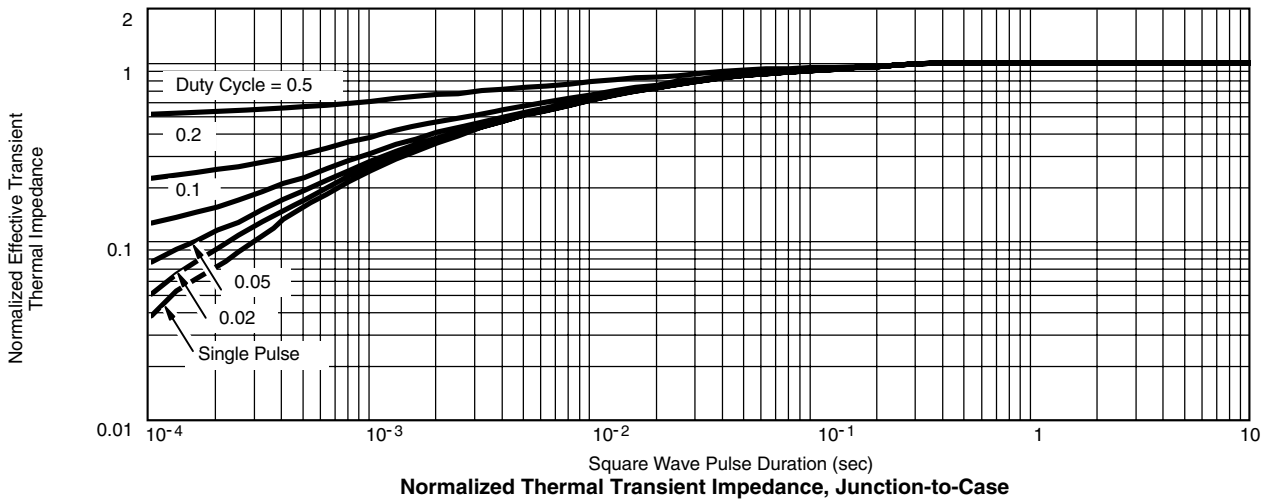

Normalized Thermal Transient Impedance, Junction-to-Case

Package Mechanical Data TO-252

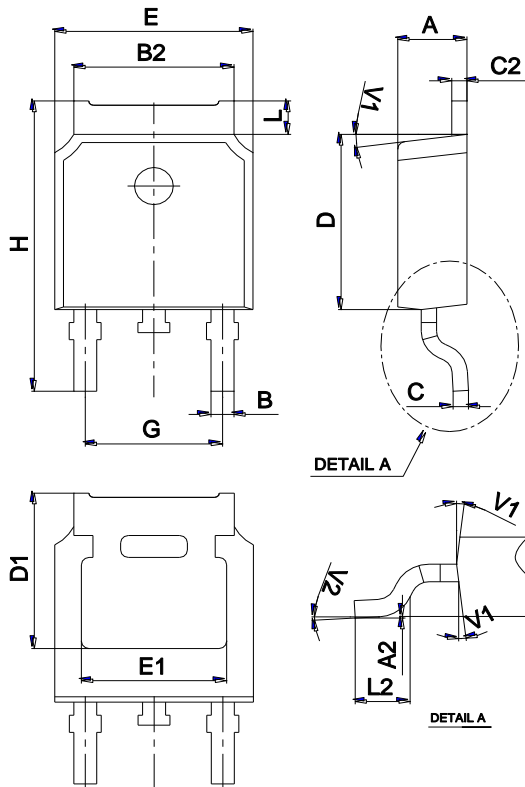

| Ref. | Dimensions | | | | | |
|------|-------------|------|-------|----------|------|-------|
| | Millimeters | | | Inches | | |
| | Min. | Typ. | Max. | Min. | Typ. | Max. |
| A | 2.10 | | 2.50 | 0.083 | | 0.098 |
| A2 | 0 | | 0.10 | 0 | | 0.004 |
| B | 0.66 | | 0.86 | 0.026 | | 0.034 |
| B2 | 5.18 | | 5.48 | 0.202 | | 0.216 |
| C | 0.40 | | 0.60 | 0.016 | | 0.024 |
| C2 | 0.44 | | 0.58 | 0.017 | | 0.023 |
| D | 5.90 | | 6.30 | 0.232 | | 0.248 |
| D1 | 5.30REF | | | 0.209REF | | |
| E | 6.40 | | 6.80 | 0.252 | | 0.268 |
| E1 | 4.63 | | | 0.182 | | |
| G | 4.47 | | 4.67 | 0.176 | | 0.184 |
| H | 9.50 | | 10.70 | 0.374 | | 0.421 |
| L | 1.09 | | 1.21 | 0.043 | | 0.048 |
| L2 | 1.35 | | 1.65 | 0.053 | | 0.065 |
| V1 | | 7° | | | 7° | |
| V2 | 0° | | 6° | 0° | | 6° |

Marking

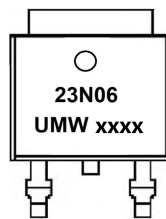

Ordering information

| Order code | Package | Baseqty | Delivery mode |
|-------------|---------|---------|---------------|
| SUD23N06-31 | TO-252 | 2500 | Tape and reel |