

CMOS – Low-Power, Slew-Rate-Limited RS-485/RS-422 Transceivers

GENERAL DESCRIPTION

The MAX1487 is low-power transceivers for RS-485 and RS-422 communication. IC contains one driver and one receiver. The driver slew rates of the MAX1487 is not limited, allowing them to transmit up to 2.5Mbps. These transceivers have A supply current of 120µA at no or full load loaded with disabled drivers. All parts operate from a single 5V supply. Drivers are short-circuit current limited and are protected against excessive power dissipation by thermal shutdown circuitry that places the driver outputs into a high-impedance state. The receiver input has a fail-safe feature that guarantees a logic-high output if the input is open circuit. The MAX1487 is designed for half-duplex applications.

FEATURES

- Extended ESD Protection for RS-485/RS-422 I/OPins ±15kV Using Human Body Model
- Low Quiescent Current: 120µA
- -7V to +12V Common-Mode Input Voltage Range
- Three-State Outputs
- 30ns Propagation Delays, 5ns Skew
- Full-Duplex and Half-Duplex Versions Available
- Operate from a Single 5V Supply
- Allows up to 32 Transceivers on the Bus
- Data rate: 2,5Mbps
- Current-Limiting and Thermal Shutdown for Driver Overload Protection

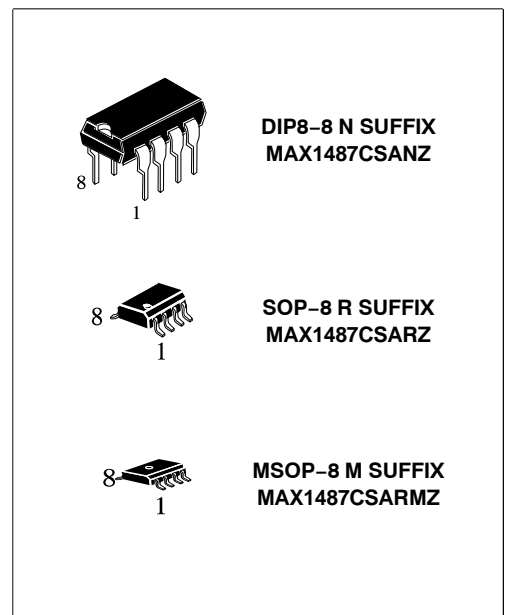

Pinning

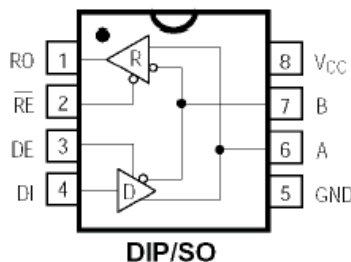

ABSOLUTE MAXIMUM RATINGS

Supply Voltage (V_{CC}) 12V
 Control Input Voltage -0.5V to ($V_{CC} + 0.5V$)
 Driver Input Voltage (DI) -0.5V to ($V_{CC} + 0.5V$)
 Driver Output Voltage (A, B) -8V to +12.5V
 Receiver Input Voltage (A, B) -8V to +12.5V
 Receiver Output Voltage (RO) -0.5V to ($V_{CC} + 0.5V$)

Continuous Power Dissipation
 8-Pin Plastic DIP (derate 9.09mW/°C) 727mW
 8-Pin SO (derate 5.88mW/°C) 471mW
 Operating Temperature Ranges -40°C to +85°C
 Storage Temperature Range -65°C to +160°C
 Lead Temperature (soldering, 10sec) +300°C

DC ELECTRICAL CHARACTERISTICS

($V_{CC} = 5V \pm 5\%$, $T_A = T_{MIN}$ to T_{MAX} , unless otherwise noted.) (Notes 1, 2)

PARAMETER	SYMBOL	CONDITIONS	MIN	TYP	MAX	UNITS
Differential Driver Output (no load)	VOD1				5	V
Differential Driver Output (with load)	VOD2	R = 50Ω (RS-422)	2			V
		R = 27Ω (RS-485), Figure 4	1.5		5	
Change in Magnitude of Driver Differential Output Voltage for Complementary Output States	ΔVOD	R = 27Ω or 50Ω, Figure 4			0.2	V
Driver Common-Mode Output Voltage	VOC	R = 27Ω or 50Ω, Figure 4			3	V
Change in Magnitude of Driver Common-Mode Output Voltage for Complementary Output States	ΔVOC	R = 27Ω or 50Ω, Figure 4			0.2	V
Input High Voltage	VIH	DE, DI, RE	2.0			V
Input Low Voltage	VIL	DE, DI, RE			0.8	V
Input Current	IIN1	DE, DI, RE			±2	μA
Input Current (A, B)	IIN2	DE = 0V;	VIN = 12V		1.0	mA
		VCC = 0V or 5.25V,	VIN = -7V		-0.8	
Receiver Differential Threshold Voltage	VTH	-7V ≤ V _{CM} ≤ 12V	-0.2		0.2	V
Receiver Input Hysteresis	ΔVTH	V _{CM} = 0V		70		mV
Receiver Output High Voltage	VOH	IO = -4mA, VID = 200mV	3.5			V
Receiver Output Low Voltage	VOL	IO = 4mA, VID = -200mV			0.4	V
Three-State (high impedance) Output Current at Receiver	IOZR	0.4V ≤ VO ≤ 2.4V			±1	μA
Receiver Input Resistance	RIN	-7V ≤ V _{CM} ≤ 12V				kΩ

DC ELECTRICAL CHARACTERISTICS (continued)

($V_{CC} = 5V \pm 5\%$, $T_A = T_{MIN}$ to T_{MAX} , unless otherwise noted.) (Notes 1, 2)

PARAMETER	SYMBOL	CONDITIONS	MIN	TYP	MAX	UNITS
No-Load Supply Current (Note 3)	ICC	DE = V _{CC}		500	900	
		RE = 0V or V _{CC}		300	500	μA
		DE = 0V				
Driver Short-Circuit Current,						
	IOSD1	-7V ≤ VO ≤ 12V (Note 4)	35		250	mA
VO = High						
Driver Short-Circuit Current,						
	IOSD2	-7V ≤ VO ≤ 12V (Note 4)	35		250	mA
VO = Low						
Receiver Short-Circuit Current	IOSR	0V ≤ VO ≤ V _{CC}	7		95	mA

SWITCHING CHARACTERISTICS(V_{CC} = 5V ±5%, T_A = T_{MIN} to T_{MAX}, unless otherwise noted.) (Notes 1, 2)

PARAMETER	SYMBOL	CONDITIONS	MIN	TYP	MAX	UNITS
Driver Input to Output	tPLH	RDIFF = 54Ω	10	30	60	ns
	tPHL	CL1 = CL2 = 100pF	10	30	60	
Driver Output Skew to Output	tSKEW	RDIFF = 54Ω, CL1 = CL2 = 100pF		5	10	ns
Driver Enable to Output High	tZH	CL = 100pF, S2 closed		40	70	ns
Driver Enable to Output Low	tZL	CL = 100pF, S1 closed		40	70	ns
Driver Disable Time from Low	tLZ	CL = 15pF, S1 closed		40	70	ns
Driver Disable Time from High	tHZ	CL = 15pF, S2 closed		40	70	ns
tPLH - tPHL Differential	tSKD	RDIFF = 54Ω		13		ns
Receiver Skew		CL1 = CL2 = 100pF				
Receiver Enable to Output Low	tZL	CRL = 15pF, S1 closed		20	50	ns
Receiver Enable to Output High	tZH	CRL = 15pF, S2 closed		20	50	ns
Receiver Disable Time from Low	tLZ	CRL = 15pF, S1 closed		20	50	ns
Receiver Disable Time from High	tHZ	CRL = 15pF, S2 closed		20	50	ns
Maximum Data Rate	fMAX		2.5			Mbps

Notes:

1. All currents into device pins are positive; all currents out of device pins are negative. All voltages are referenced to device ground unless otherwise specified.
2. All typical specifications are given for V_{CC} = 5V and T_A = +25°C
3. Supply current specification is valid for loaded transmitters when DE = 0V
4. Applies to peak current. See *Typical Operating Characteristics*.

Operation timing diagrams

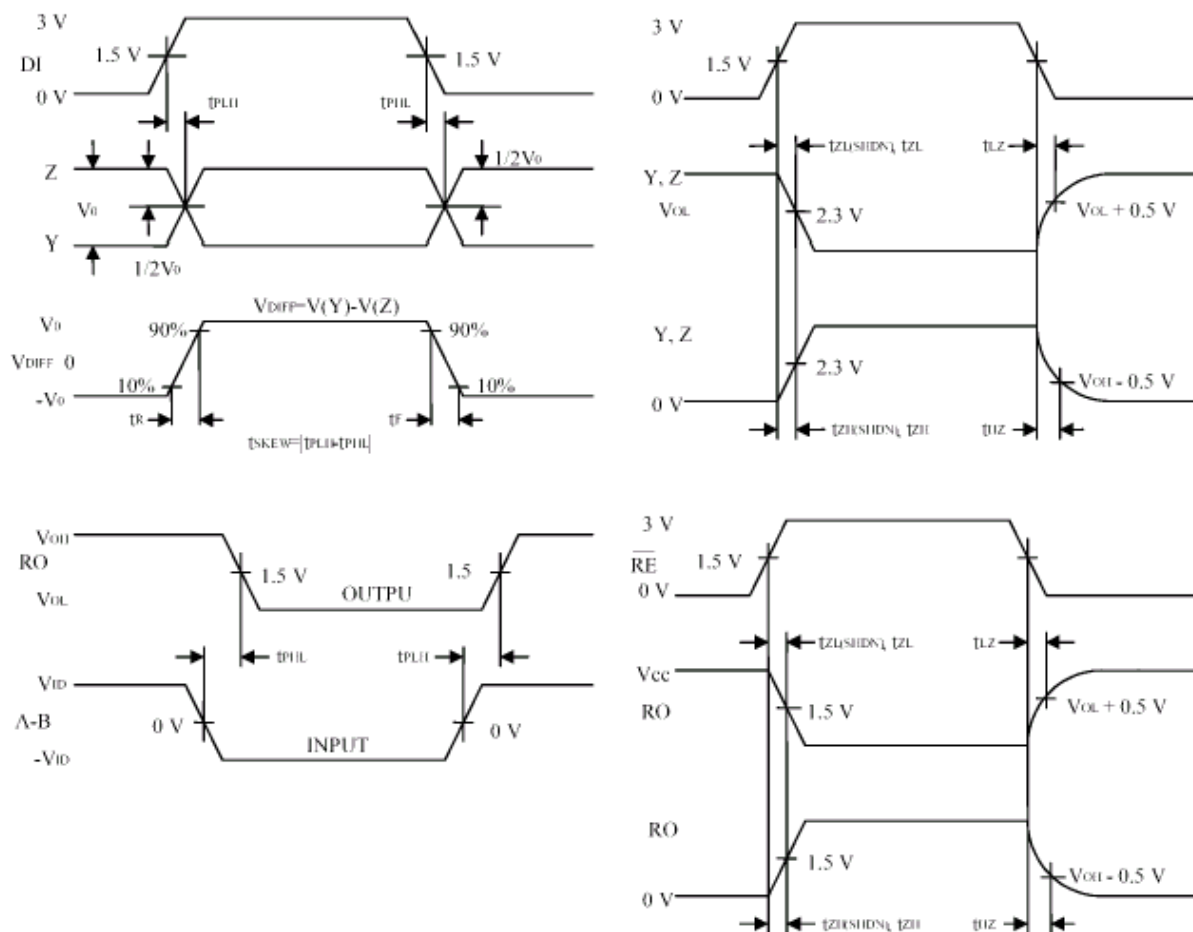

Transmission					Receipt			
Inputs			Outputs X		Inputs			Outputs
RE	DE	DI	Z	Y	RE	DE	A-B	RO
X	1	1	0	1	0	0	+0.2V	1
X	1	0	1	0	0	0	-0.2V	0
0	0	X	Z	Z	0	0	open	1
1	0	X	Z	Z	1	0	X	Z

X-don't care

Z-high resistance

(DIP8)

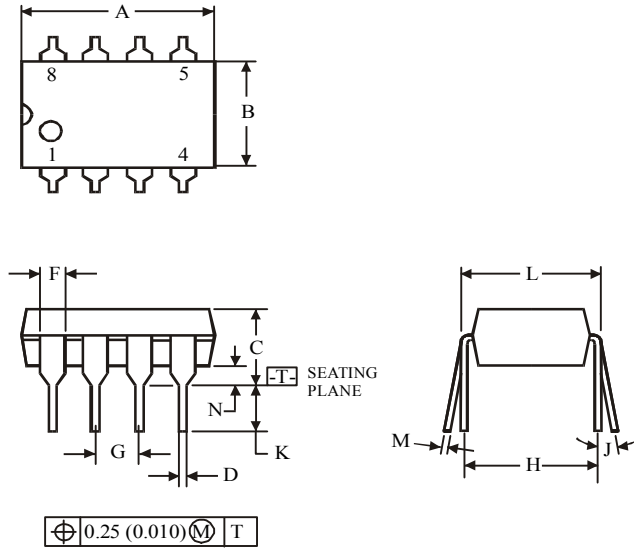
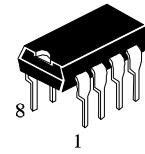

Symbol	Dimension, mm	
	MIN	MAX
A	8.51	10.16
B	6.1	7.11
C		5.33
D	0.36	0.56
F	1.14	1.78
G	2.54	
H	7.62	
J	0°	10°
K	2.92	3.81
L	7.62	8.26
M	0.2	0.36
N	0.38	

NOTES:

- Dimensions "A", "B" do not include mold flash or protrusions.
Maximum mold flash or protrusions 0.25 mm (0.010) per side.

(SOP8)

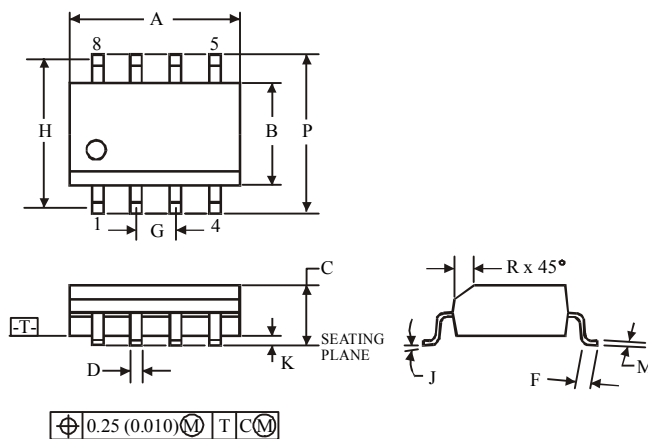
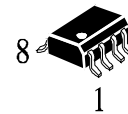

Symbol	Dimension, mm	
	MIN	MAX
A	4.8	5
B	3.8	4
C	1.35	1.75
D	0.33	0.51
F	0.4	1.27
G	1.27	
H	5.72	
J	0°	8°
K	0.1	0.25
M	0.19	0.25
P	5.8	6.2
R	0.25	0.5

NOTES:

- Dimensions A and B do not include mold flash or protrusion.
- Maximum mold flash or protrusion 0.15 mm (0.006) per side for A; for B - 0.25 mm (0.010) per side.