

1 Features

- Wide Supply Ranges
 - Single Supply: 3 V to 32 V (26 V for LM2902)
 - Dual Supplies: ± 1.5 V to ± 16 V (± 13 V for LM2902)
- Low Supply-Current Drain Independent of Supply Voltage: 0.8 mA Typical
- Common-Mode Input Voltage Range Includes Ground, Allowing Direct Sensing Near Ground
- Low Input Bias and Offset Parameters
 - Input Offset Voltage: 3 mV Typical
 - Input Offset Current: 2 nA Typical
 - Input Bias Current: 20 nA Typical
- Differential Input Voltage Range Equal to Maximum-Rated Supply Voltage: 32 V (26 V for LM2902)
- Open-Loop Differential Voltage Amplification: 100 V/mV Typical
- Internal Frequency Compensation
- On Products Compliant to MIL-PRF-38535, All Parameters are Tested Unless Otherwise Noted. On All Other Products, Production Processing Does Not Necessarily Include Testing of All Parameters.

2 Applications

- Blu-ray Players and Home Theaters
- Chemical and Gas Sensors
- DVD Recorders and Players
- Digital Multimeter: Bench and Systems
- Digital Multimeter: Handhelds
- Field Transmitter: Temperature Sensors
- Motor Control: AC Induction, Brushed DC, Brushless DC, High-Voltage, Low-Voltage, Permanent Magnet, and Stepper Motor
- Oscilloscopes
- TV: LCD and Digital
- Temperature Sensors or Controllers Using Modbus
- Weigh Scales

3 Description

These devices consist of four independent high-gain frequency-compensated operational amplifiers that are designed specifically to operate from a single supply or split supply over a wide range of voltages.

Symbol (Each Amplifier)

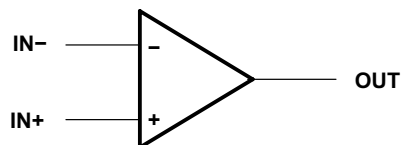

4 Pin Configuration and Functions

DR
14-Pin SOP, DIP

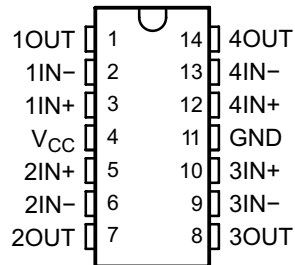

Pin Functions

PIN			I/O	DESCRIPTION
NAME	LCCC NO.	SOP, DIP		
1IN-		2	I	Negative input
1IN+		3	I	Positive input
1OUT		1	O	Output
2IN-		6	I	Negative input
2IN+		5	I	Positive input
2OUT		7	O	Output
3IN-		9	I	Negative input
3IN+		10	I	Positive input
3OUT		8	O	Output
4IN-		13	I	Negative input
4IN+		12	I	Positive input
4OUT		14	O	Output
GND		11	—	Ground
V _{CC}	6	4	—	Power supply

5 Specifications

5.1 Absolute Maximum Ratings

over operating free-air temperature range (unless otherwise noted)⁽¹⁾

	LM2902		LM124, LM224		UNIT
	MIN	MAX	MIN	MAX	
Supply voltage, V_{CC} ⁽²⁾	±13	26	±16	32	V
Differential input voltage, V_{ID} ⁽³⁾	±26		±32		V
Input voltage, V_I (either input)	-0.3	26	-0.3	to 32	V
Duration of output short circuit (one amplifier) to ground at (or below) $T_A = 25^\circ\text{C}$, $V_{CC} \leq 15\text{ V}$ ⁽⁴⁾	Unlimited		Unlimited		
Operating virtual junction temperature, T_J	150		150		°C
Storage temperature, T_{stg}	-65	150	-65	150	°C

- (1) Stresses beyond those listed under *Absolute Maximum Ratings* may cause permanent damage to the device. These are stress ratings only, and functional operation of the device at these or any other conditions beyond those indicated under *Recommended Operating Conditions* is not implied. Exposure to absolute-maximum-rated conditions for extended periods may affect device reliability.
- (2) All voltage values (except differential voltages and V_{CC} specified for the measurement of I_{OS}) are with respect to the network GND.
- (3) Differential voltages are at $IN+$, with respect to $IN-$.
- (4) Short circuits from outputs to V_{CC} can cause excessive heating and eventual destruction.

5.2 ESD

LM124, LM224, LM2902			
$V_{(ESD)}$ Electrostatic discharge	Human-body model (HBM), per ANSI/ESDA/JEDEC JS-001 ⁽¹⁾	±500	V
	Charged-device model (CDM), per JEDEC specification JESD22-C101	±1000	

- (1) JEDEC document JEP155 states that 500-V HBM allows safe manufacturing with a standard ESD control process.

5.3 Recommended Operating Conditions

over operating free-air temperature range (unless otherwise noted)

	LM2902		LM124, LM224		UNIT
	MIN	MAX	MIN	MAX	
V_{CC} Supply voltage	3	26	3	30	V
V_{CM} Common-mode voltage	0	$V_{CC} - 2$	0	$V_{CC} - 2$	V
T_A Operating free air temperature	LM124		-55	125	°C
	LM2902	-40	105		
	LM224		-20	85	

5.4 Thermal Information

THERMAL METRIC ⁽¹⁾	LM124, LM224, LM2902		
	(SOP)	(DIP)	UNIT
	14 PINS	14 PINS	
R _{θJA} ⁽²⁾⁽³⁾ Junction-to-ambient thermal resistance	86	80	°C/W
R _{θJC} ⁽⁴⁾ Junction-to-case (top) thermal resistance	—	—	

- (1) Short circuits from outputs to VCC can cause excessive heating and eventual destruction.
- (2) Maximum power dissipation is a function of T_{J(max)}, R_{θJA}, and T_A. The maximum allowable power dissipation at any allowable ambient temperature is P_D = (T_{J(max)} - T_A)/R_{θJA}. Operating at the absolute maximum T_J of 150°C can affect reliability.
- (3) Maximum power dissipation is a function of T_{J(max)}, R_{θJA}, and T_C. The maximum allowable power dissipation at any allowable case temperature is P_D = (T_{J(max)} - T_C)/R_{θJC}. Operating at the absolute maximum T_J of 150°C can affect reliability.

5.5 Electrical Characteristics for LMx24

at specified free-air temperature, V_{CC} = 5 V (unless otherwise noted)

PARAMETER	TEST CONDITIONS ⁽¹⁾	T _A ⁽²⁾	LM124, LM224			UNIT	
			MIN	TYP ⁽³⁾	MAX		
V _{IO} Input offset voltage	V _{CC} = 5 V to MAX, V _{IC} = V _{ICRmin} , V _O = 1.4 V	25°C	3		5	mV	
		Full range			7		
I _{IO} Input offset current	V _O = 1.4 V	25°C	2		30	nA	
		Full range			100		
I _{IB} Input bias current	V _O = 1.4 V	25°C	-20		-150	nA	
		Full range			-300		
V _{ICR} Common-mode input voltage range	V _{CC} = 5 V to MAX	25°C	0 to V _{CC} - 1.5			V	
		Full range	0 to V _{CC} - 2				
V _{OH} High-level output voltage	R _L = 2 kΩ	25°C	V _{CC} - 1.5			V	
	R _L = 10 kΩ	25°C					
	V _{CC} = MAX	R _L = 2 kΩ	Full range	26			
		R _L ≥ 10 kΩ	Full range	27			28
V _{OL} Low-level output voltage	R _L ≤ 10 kΩ	Full range	5		20	mV	
A _{VD} Large-signal differential voltage amplification	V _{CC} = 15 V, V _O = 1 V to 11 V, R _L ≥ 2 kΩ	25°C	50		100	V/mV	
		Full range	25				
CMRR Common-mode rejection ratio	V _{IC} = V _{ICRmin}	25°C	70		80	dB	
k _{SVR} Supply-voltage rejection ratio (ΔV _{CC} /ΔV _{IO})		25°C	65		100	dB	
V _{O1} /V _{O2} Crosstalk attenuation	f = 1 kHz to 20 kHz	25°C	120			dB	
I _O Output current	V _{CC} = 15 V, V _{ID} = 1 V, V _O = 0	Source	25°C	-20		-30	mA
			Full range	-10			
	V _{CC} = 15 V, V _{ID} = -1 V, V _O = 15 V	Sink	25°C	10		20	
			Full range	5			
	V _{ID} = -1 V, V _O = 200 mV	25°C	12		30	μA	
I _{OS} Short-circuit output current	V _{CC} at 5 V, V _O = 0, GND at -5 V	25°C	±40		±60	mA	
I _{CC} Supply current (four amplifiers)	V _O = 2.5 V, no load	Full range	0.7		1.2	mA	
	V _{CC} = MAX, V _O = 0.5 V _{CC} , no load	Full range	1.4		3		

- (1) All characteristics are measured under open-loop conditions, with zero common-mode input voltage, unless otherwise specified. MAX V_{CC} for testing purposes is 26 V for LM2902 and 30 V for the others.
- (2) Full range is -55°C to 125°C for LM124, -20°C to 85°C for LM224
- (3) All typical values are at T_A = 25°C

5.6 Operating Conditions

$V_{CC} = \pm 15\text{ V}$, $T_A = 25^\circ\text{C}$

PARAMETER		TEST CONDITIONS	TYP	UNIT
SR	Slew rate at unity gain	$R_L = 1\text{ M}\Omega$, $C_L = 30\text{ pF}$, $V_I = \pm 10\text{ V}$ (see Figure 7)	0.5	V/ μ s
B ₁	Unity-gain bandwidth	$R_L = 1\text{ M}\Omega$, $C_L = 20\text{ pF}$ (see Figure 7)	1.2	MHz
V _n	Equivalent input noise voltage	$R_S = 100\ \Omega$, $V_I = 0\text{ V}$, $f = 1\text{ kHz}$ (see Figure 8)	35	nV/ $\sqrt{\text{Hz}}$

5.7 Typical Characteristics

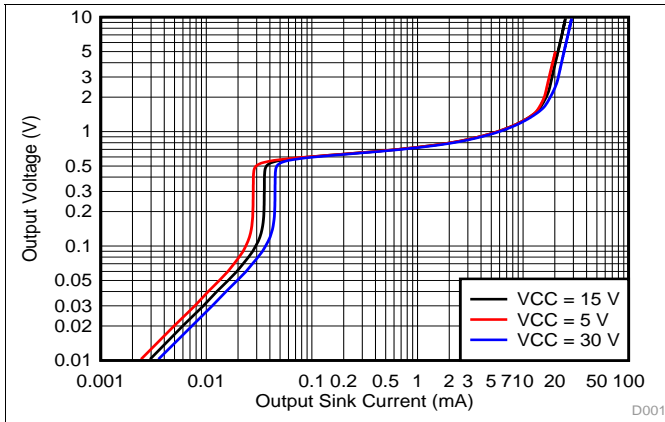

Figure 1. Output Sinking Characteristics

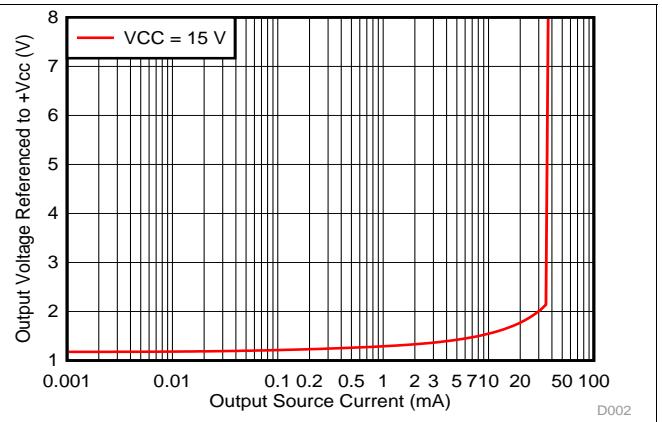

Figure 2. Output Sourcing Characteristics

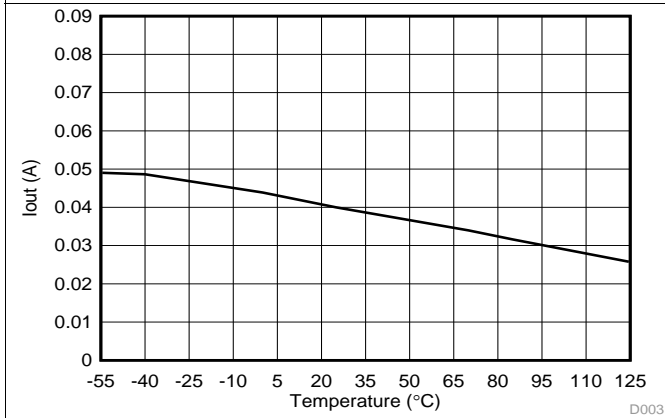

Figure 3. Source Current Limiting

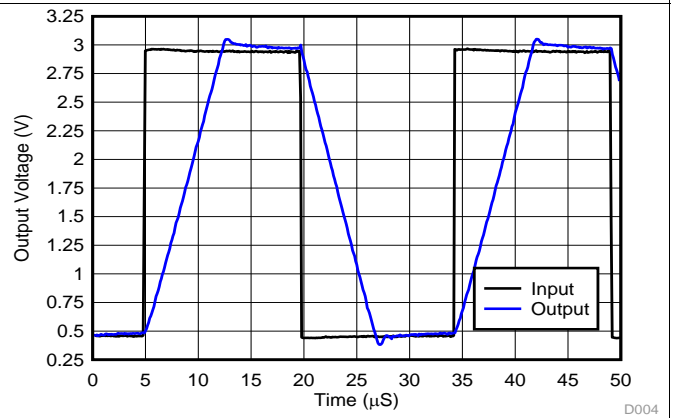

Figure 4. Voltage Follower Large Signal Response (50 pF)

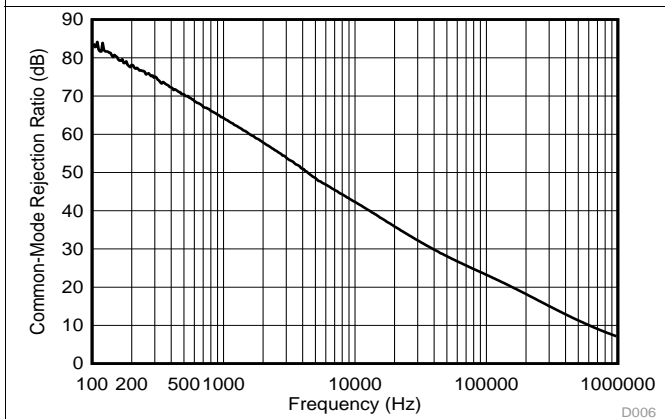

Figure 5. Common-Mode Rejection Ratio

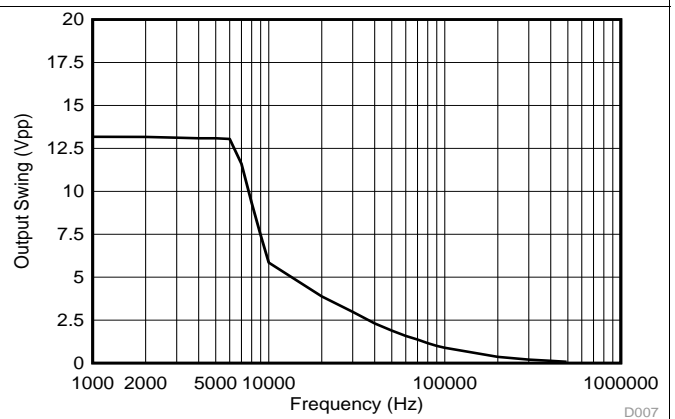

Figure 6. Maximum Output Swing vs. Frequency (VCC = 15 V)

6 Parameter Measurement Information

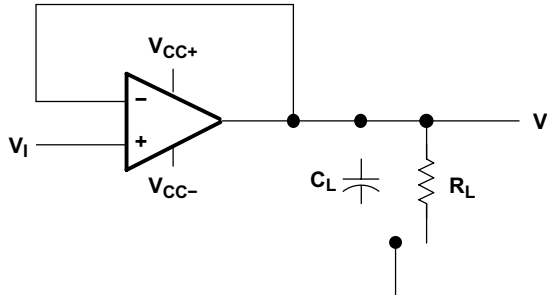

Figure 7. Unity-Gain Amplifier

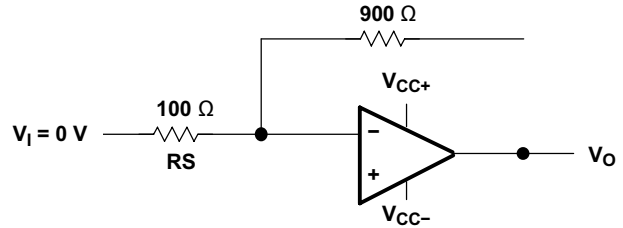

Figure 8. Noise-Test Circuit

7 Detailed Description

7.1 Overview

These devices consist of four independent high-gain frequency-compensated operational amplifiers that are designed specifically to operate from a single supply over a wide range of voltages. Operation from split supplies also is possible if the difference between the two supplies is 3 V to 32 V (3 V to 26 V for the LM2902 device), and V_{CC} is at least 1.5 V more positive than the input common-mode voltage. The low supply-current drain is independent of the magnitude of the supply voltage.

Applications include transducer amplifiers, DC amplification blocks, and all the conventional operational-amplifier circuits that now can be more easily implemented in single-supply-voltage systems. For example, the LM124 device can be operated directly from the standard 5-V supply that is used in digital systems and provides the required interface electronics, without requiring additional ± 15 -V supplies.

7.2 Functional Block Diagram

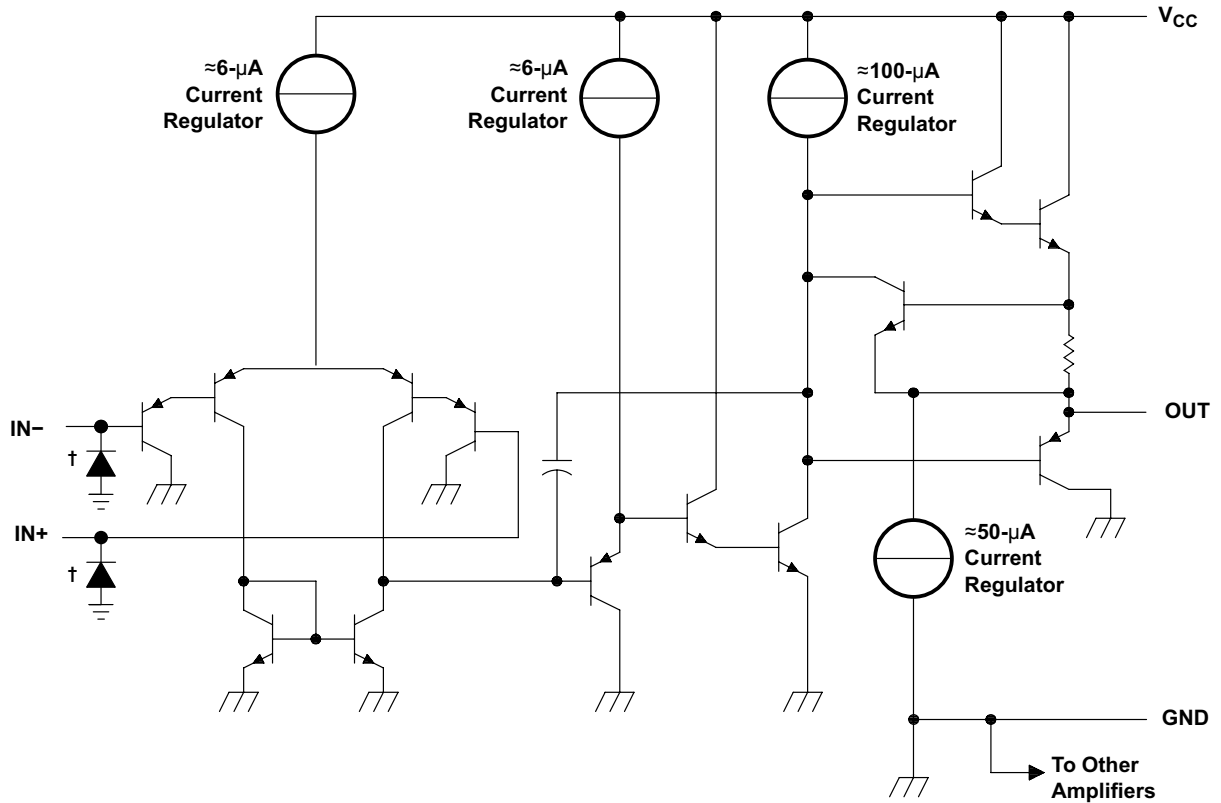

COMPONENT COUNT (total device)	
Epi-FET	1
Transistors	95
Diodes	4
Resistors	11
Capacitors	4

PACKAGE

SOP14

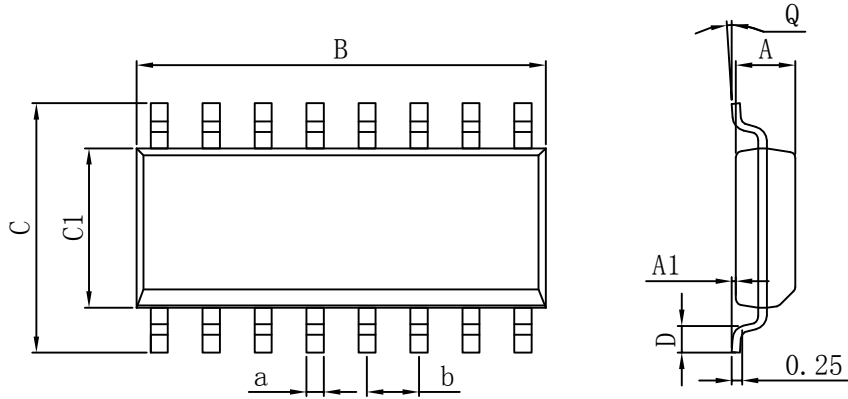

UNIT: mm							
DIM.	MIN	TYP	MAX	DIM.	MIN	TYP	MAX
A	4.520	4.570	4.620	a	0.400	0.420	0.440
A1	0.100	-	0.250	b	1.260	1.270	1.280
B	8.500	8.750	9.000	Q	0°	-	8°
C	5.800	6.100	6.250				
C1	3.800	3.900	4.000				
D	0.400	-	0.950				

DIP14

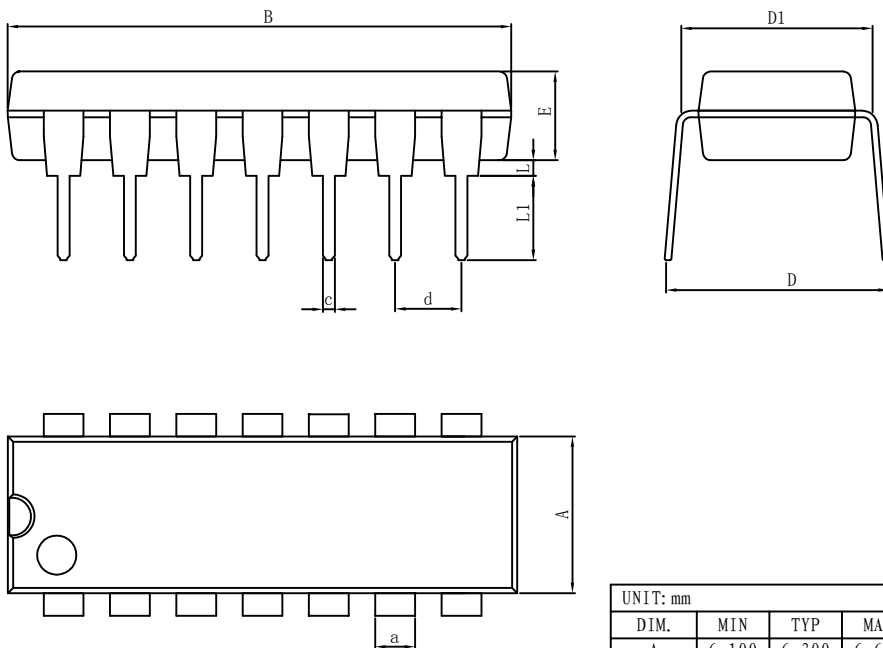

UNIT: mm							
DIM.	MIN	TYP	MAX	DIM.	MIN	TYP	MAX
A	6.100	6.300	6.680	a	1.504	1.524	1.544
B	18.940	19.200	19.560	c	0.437	0.457	0.477
D	8.200	8.700	9.200	d	2.530	2.540	2.550
D1	7.42	7.62	7.82	L	0.500	-	0.800
E	3.100	3.300	3.550	L1	3.000	3.200	3.600